

RADIO'S GREATEST MAGAZINE

RADIO-CRAFT

Incorporating

**RADIO &
TELEVISION**

LEO GERNSBACK, Editor



**MANY ARTICLES
FOR THE
RADIO
BEGINNER**

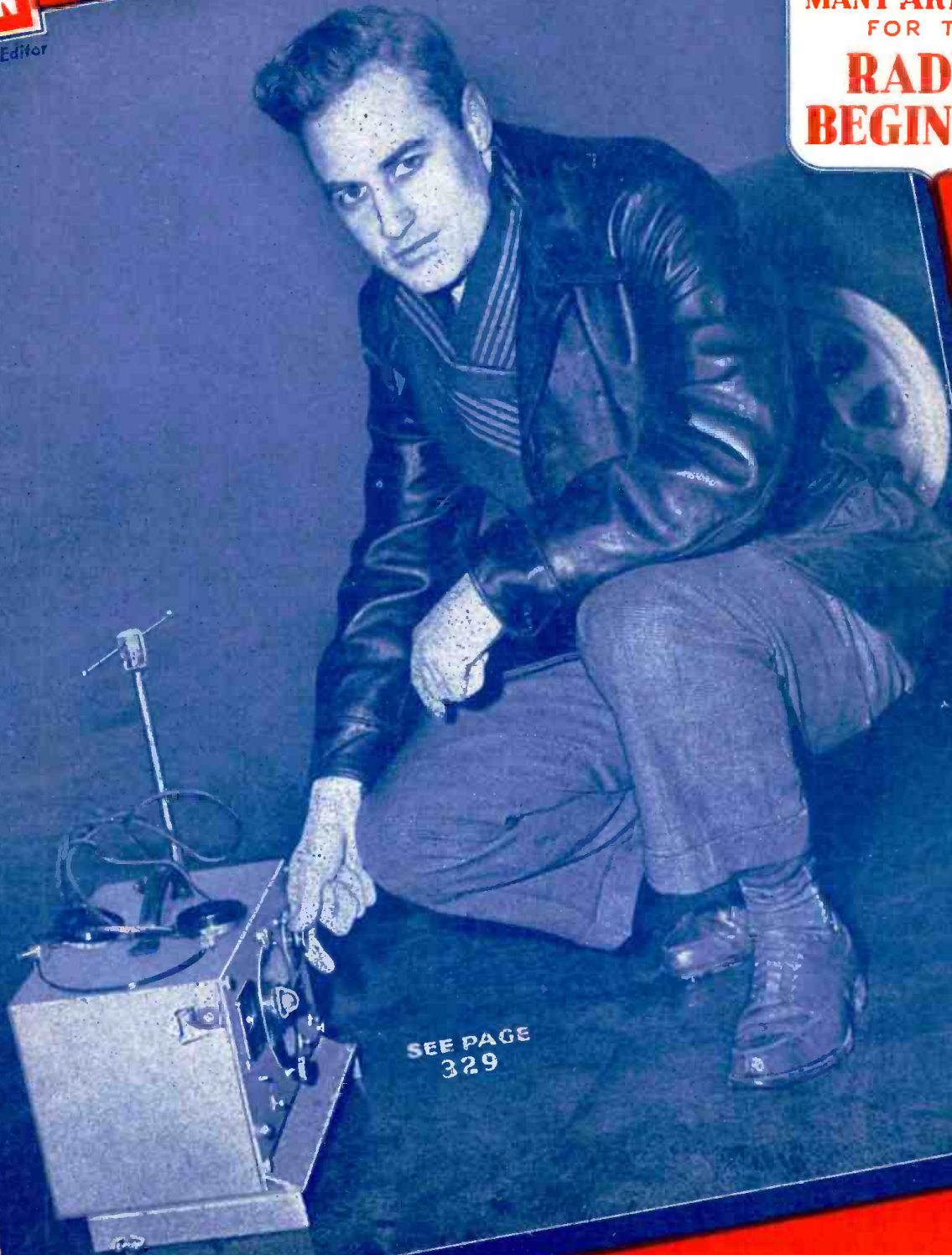

SEE PAGE
329

25¢

CANADA 30¢

(1941)

OVER 100 ILLUSTRATIONS

FIX ANY RADIO

Amazing New Invention

**Simplified
Radio
Servicing
by
Comparison
Method**

Learn radio by a simplified method. Repair radios in minutes instead of hours. Revolutionary, different Comparison technique permits you to do expert work almost immediately. Most repairs can be made without test equipment. Simple point-to-point, cross-reference, circuit suggestions locate faults quickly and easily.

COMPLETE
\$1.50
ONLY
SPECIAL OFFER
READ THE DETAILS

FOR BEGINNERS OR EXPERTS

Understand radio principles; find any radio fault with ease. Follow the comparison tests given on 16 large trouble-shooting blueprints. Over 1,000 practical repair hints. Hundreds of simplified tests using a 5¢ resistor and a filter condenser. Covers every radio set—new and old. Introductory material for beginners and to serve as a review for experienced radio men. Also several chapters on test equipment. Presented in manual form, 112 fact pages 8½ x 11 inches. Entire plan is stark new and will help you get ahead in radio quickly.



Developed by M. N. Beltman, radio engineer, teacher, author, & serviceman.

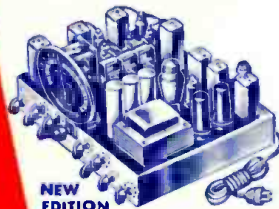

NEW EDITION

REPAIR ANY RADIO IN MINUTES

Learn how to localize the trouble without any equipment. Make tests, measure voltage, trace the signal with a resistor, small condenser, and a crystal detector. Inject signals without any signal generator. Test parts by the new Comparison method. Test tubes without equipment. Repair any radio expertly following illustrated, simplified plans. Improve your radio servicing ability. Examine the plan without obligations—without risk. Send coupon.



PRACTICAL USEFUL FACTS AND HINTS

Hundreds of service hints, trouble-shooting ideas, simplified tests, repair suggestions, and alignment methods are included. Benefit by the experience of others. Use the most practical method for finding the fault and making the repair. Save time on every job.

FIX MOST SETS WITHOUT TESTERS

Follow the COMPARISON technique and repair 4 out of 5 sets without equipment. Speed up your work; locate faults quickly; make repairs efficiently. Be fair with yourself and try this new plan without obligation. Take advantage of our "no-risk" trial. Send coupon today. Use this time-saving, money-making radio servicing training for 10 days without any obligations. See how quickly you will learn helpful methods. Save time every day on every radio job. Learn new short-cuts in radio servicing. Get ahead in Radio. Repair sets for fun and profit. Prepare for higher rank and better pay in the Army. Act today.



MONEY-BACK GUARANTEE

You must be entirely satisfied or your money will be refunded without a question. The training will more than pay for itself on the first radio job or with higher rank in the Army. Examine and use this unique plan for 10 days at our risk. Send coupon right now—use the plan this week.

Other Practical Radio Manuals

How to MODERNIZE RADIOS for Profit



Cash in by improving audio circuits, modernizing cabinets, adding features usually found on late model sets. Practical job-sheets with schematics and photographs make the work easy. You are told how to obtain modernization work, what to charge, and how to complete the job quickly and efficiently. Large size, 8½ x 11 in. manual is priced at only **\$1.00**

MOST-OFTEN-NEEDED RADIO DIAGRAMS



The most popular radio diagrams available in low priced manuals. Large size: 8½ x 11 inches.
1942 Manual, Volume 5, 204 pages....
1941 Manual, Volume 4, 192 pages....
1940 Manual, Volume 3, 208 pages....
1939 Manual, Volume 2, 192 pages....
1926-38 Manual, Volume 1, 244 pages, alignment, hints, parts lists.....
\$2.00 each NET \$2.50

PRACTICAL RADIO MATHEMATICS



Introduces and explains the use of arithmetic and elementary algebra in connection with units, color code, meter scales, Ohm's Law, alternating currents, ohmmeter testing, wattage rating, series and parallel connections, capacity, inductance, mixed circuits, vacuum tubes, curves, the decibel, etc., etc., and has numerous examples. Net..... **25c**

SEE YOUR RADIO JOBBER OR SEND COUPON

"NO RISK" TRIAL ORDER COUPON

SUPREME PUBLICATIONS, 328 S. Jefferson St., Chicago, Ill.

Ship my copy of the complete Simplified Radio Servicing by COMPARISON Method manual. I must be entirely satisfied or you will refund my total remittance.

- I am enclosing \$1.50, full price. Send postpaid.
- Send C.O.D. I will pay the mailman \$1.50 and a few cents postage.
- Also send other Supreme Publications books as listed on attached paper.

NAME

ADDRESS

Supreme Publications

PUBLISHERS OF RADIO BOOKS, MANUALS, AND DIAGRAMS

328 South Jefferson Street

Chicago, Illinois



J. E. SMITH, President,
NATIONAL RADIO INSTITUTE
Established 28 Years

He has directed the training of more men for the Radio Industry than any other man in America.



THE 915 U. S. BROADCASTING STATIONS give steady jobs to thousands of Radio Technicians, Operators, with average pay among the country's highest paid industries.



RADIO REPAIRING is a booming business today because no new Radios are being made. Many make \$30, \$40, \$50 a week in full time jobs—others \$5, \$10 a week EXTRA for spare time work!



CIVILIAN RADIO OPERATORS are needed for good Government jobs and in Aviation Radio, Police Radio, Commercial Radio. Opportunities are increasing in these fields!

I Trained These Men



Chief Operator Broadcasting Station
"Before I completed your lessons, I obtained my Radio Broadcast Operator's license and immediately joined Station WMPQ where I am now Chief Operator."
HOLLIS F. HAYES, 327 Madison St., Lapeer, Mich.

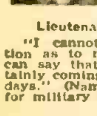

Lieutenant in Signal Corps
"I cannot divulge any information as to my type of work but I can say that N.R.I. training is certainly coming in mighty handy these days." (Name and address omitted for military reasons.)



\$10 a Week in Spare Time
"I repaired some Radio sets when I was on my tenth lesson. I really don't see how you can give so much for such a small amount of money. I made \$600 in a year and a half, and I have made an average of \$10 a week just spare time."
JOHN JERRY, 1537 Kalamath St., Denver, Colorado.

I will send you a Lesson Free to show how I train you at home in spare time for Good Jobs in Radio

Mail the Coupon for a FREE lesson from my Radio Course. It shows you how N.R.I. trains you for Radio at home in spare time. And with this sample lesson I'll send my 64-page illustrated book, RICH REWARDS IN RADIO. It describes the many fascinating jobs Radio offers, explains the unique training methods I have perfected during my 28 years of teaching Radio by mail.

Act Now! Many Radio Technicians Make \$30, \$40, \$50 a Week

Right now, in nearly every neighborhood, there's room for more spare and full time Radio Technicians. Many Radio Technicians are stepping into good spare time and full time Radio Jobs, or are starting their own shops, and are making \$30, \$40, \$50 a week!

Others take good-pay jobs with Broadcasting Stations. Hundreds more are needed for Government jobs as Civilian Radio Operators, Technicians, Radio Manufacturers, rushing to fill Government orders, need trained men. Aviation, Police, Commercial Radio

and Loudspeaker Systems are live, growing fields. And think of the NEW jobs Television and other Radio developments will open after the war! I give you the Radio knowledge required for these fields.

How My Tested Method Helps Many Make \$5, \$10 a Week EXTRA While Learning

Many N.R.I. Students make \$5, \$10 a week extra money fixing Radios in spare time while learning. I send EXTRA MONEY JOB SHEETS that tell how to do it!

My Course is so interesting, with hundreds of pictures, charts and diagrams—so easy-to-grasp, with special teaching methods designed especially for home training—that we believe you will be "old friends" with Radio almost before you know it. You run your own Spare Time Shop, get practice fixing Radios, get paid while training!

Find Out What N.R.I. Can Do For You

MAIL THE COUPON for FREE sample lesson and my 64-page book. You'll discover things you never knew about Broadcasting, Radio Servicing, Manufacturing, other interesting profitable Radio fields. You'll read a complete description of my Course. You'll see the many fascinating jobs Radio offers and how you can get started. You'll read letters from many men I trained. Mail Coupon AT ONCE! J. E. Smith, President, Dept. 3CX, National Radio Institute, Washington, D. C.

TRAINING MEN FOR VITAL RADIO JOBS

FREE LESSON

I'll send you a FREE lesson, "Getting Acquainted with Radio Servicing," to show how practical it is to train at home for Radio. It's a valuable lesson. Keep it—use it—without obligation. Tells how Superheterodyne Receivers work—why Tubes fail—how to fix Electrodynamic Speakers, Output Transformers. Gives hints on I.F. Transformer repair—how to locate defective soldered joints—Antenna, Oscillator Coil facts—Receiver Servicing Technique, etc., etc., 31 illustrations.

Good for Both 64 PAGE BOOK SAMPLE LESSON Free

J. E. SMITH, President,
National Radio Institute, Dept. 3CX, Washington, D. C.

Without obligating me, mail your Sample Lesson and 64-page Book FREE. I am particularly interested in the branch of Radio checked below. (No salesmen will call. Write plainly.)

- | | |
|--|--|
| <input type="checkbox"/> Radio Service Business of My Own | <input type="checkbox"/> Aviation Radio |
| <input type="checkbox"/> Service Technician for Radio Stores | <input type="checkbox"/> Operating Broadcasting Stations |
| <input type="checkbox"/> Spare Time Radio Servicing | <input type="checkbox"/> Army, Navy Radio |
| <input type="checkbox"/> Gov't Civilian Radio Job | <input type="checkbox"/> Operating Police Radio Stations |
| | <input type="checkbox"/> Operating Ship and Harbor Radio |

(If you have not decided which branch you prefer—mail coupon for facts to help you decide.)

Name Age.....
Address
City State AFR-3

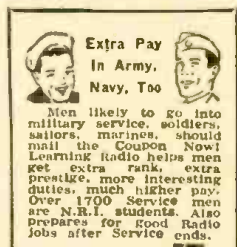

Extra Pay In Army, Navy, Too
Men likely to go into military service, soldiers, sailors, marines, should mail the Coupon Now! Learning Radio helps men get extra rank, extra prestige, more interesting duties, much higher pay. Over 1700 Service men are N.R.I. students. Also Prepares for Good Radio Jobs after Service ends.



RADIO-CRAFT

Incorporating

RADIO & TELEVISION

HUGO GERNSBACK
Editor-in-Chief

KARL E. SCHUBEL
Associate Editor

FRED SHUNAMAN
Technical Editor

G. ALIQUO
Circulation Manager

Contents **MARCH, 1943** **Issue**

VOLUME XIV -- NUMBER 6

Mailbag	324
Editorial: Super-Electronics	by Hugo Gernsback 327
Radio Month in Review	328
Rapid Tester (cover feature)	329
Women in Radio	341

ELECTRONICS

Popular Electronics, Part II	by Raymond Francis Yates 330
Electronic Ice Indicator	332
Progress in Electronics and Radio	by Dr. E. F. W. Alexanderson 333
Photo-Electrography—Tomorrow's Miracle	by Raymond Francis Yates 334
<i>Electronics</i> is Catching on	335
Electronic Tubes for Servicemen	by Ira Kamen 336
Radio and Television After the War	by H. S. Kahn 337
Radio Frequency Voltmeter	337
Submarine Detection	by Floyd B. Neyhart 338
Electronics—Its Latest Miracles	by S. R. Winters 339
Instrument Measures Heartbeat of Unborn	340
Electronics and Industry	340

EXPERIMENTERS

All-Electric Simplicity-I	by Fred Shunaman 342
High Frequency Measurements	by John R. Kearney 344
R. F. Carrier Communications, Part I	by Werner Muller 346

SERVICING

The "Ya Mei" Multitester	by Fred Shunaman 348
RADIO SERVICE DATA SHEET: No. 331 Crosley Models 02CA and 02CB	350

SOUND

Practical Audio Amplifier Theory, Part II	by Ted Powell 352
---	-------------------



BEGINNERS

How Superhets Work	356
Simple Superhet for Beginners	by Harry Bergquist 358
Audio Frequency Amplification	360
Handy Radio Tester	by W. Neelands 362
U.H.F. Receiver	by Stanley Dowgiala 364
Portable Battery Phono Oscillator	366

TEST INSTRUMENTS

Test Equipment Maintenance	by L. W. Burt 380
Rectifier Substitutes	380

DEPARTMENTS

Mailbag	324
Radio Month in Review	328
RADIO SERVICE DATA SHEET: (See Servicing)	350
Question Box	368
Radio Hook-ups	370
Radio Kinks	374
Latest Radio Apparatus	382
Book Reviews	383



Published by Radcraft Publications, Inc. Publication office: 29 Worthington Street, Springfield, Mass. Editorial and Advertising Offices: 25 West Broadway, New York City, Chicago Advertising Office: RADIO-CRAFT, 520 North Michigan Avenue, Chicago, Ill.

RADIO-CRAFT is published monthly, on the first of the month preceding that of date; subscription price is \$2.50 per year in U. S. (In foreign countries, 75c additional per year to cover postage; Canada, 50c additional.) Entered at the post office at Springfield as second-class matter under the act of March 3, 1879. All communications about subscriptions should be addressed to: Radio-Craft, 25 West Broadway, New York, N. Y.



Foreign Agents:

London—Gorrings's American News Agency, 9A Green St., Leicester Square, W. C. 2, England.
Melbourne—McGill's Agency, 179 Elizabeth St., Australia.
Dunedin—James Johnston, Ltd., New Zealand.



Text and illustrations of this magazine are copyright and must not be reproduced without permission of the copyright owners.



Copyright 1943 Radcraft Publications, Inc.

7 Days FREE TRIAL

Costs You Nothing to Examine This Amazing New Three Volume Set of REFERENCE BOOKS OF PRACTICAL



ELECTRICITY

Each Book 8½ x 11 Inches. Handsomely Bound in Harvard Red and Gold Leatherette.

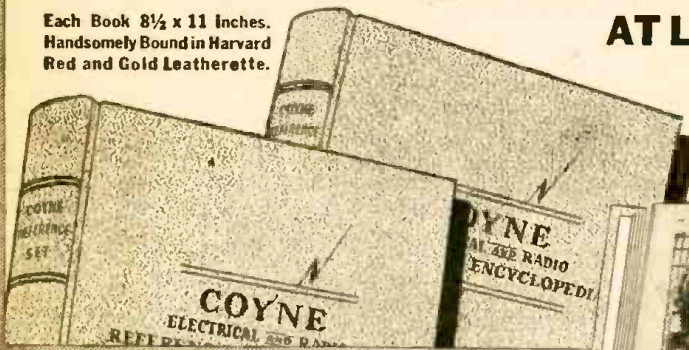

AT LAST! A set of electrical books written in clear, understandable language for the "beginner" or "old timer." Solves your everyday electrical problems easily, quickly and thoroughly.

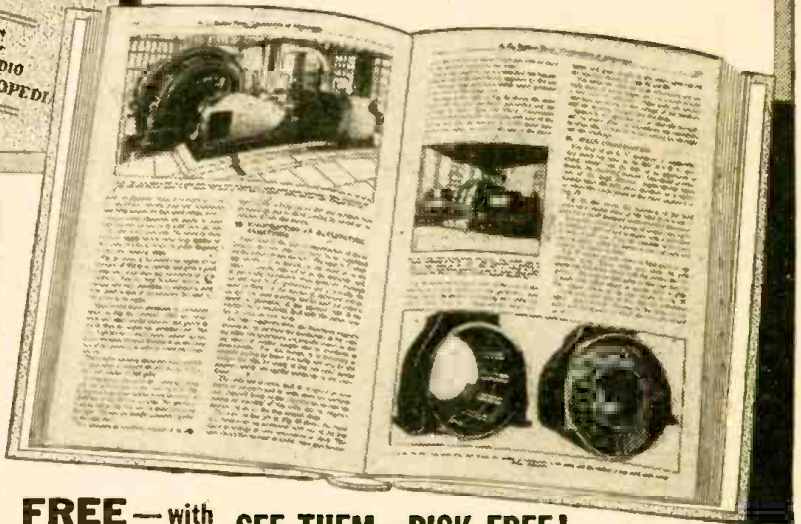

SEND NO MONEY! COUPON BRINGS COMPLETE SET!

Now at last, it's easy, practical to get a knowledge of Electricity at home. Whether you want to learn Electricity or whether you are now doing electrical work, you need these books.

AUTHORITATIVE. PRACTICAL—prepared by experts. Used regularly on the job by hundreds of Electricians, service men, radio men, air cadets, students, maintenance men, etc. **EASY. COMPLETE.** Covers everything Electrical: Armature winding, A.C. and D.C. Motors, generators, electronics, automotive electricity, refrigeration, etc., etc. Answers your electrical questions quickly, clearly, completely. Also includes Radio, Television.

FREE — with Reference Books

Send for these reference books now, and I'll include 1 full year of Technical Service—personal advice by mail on any Electrical or Radio subject.

SEE THEM—RISK FREE!

Don't send a penny. Simply mail coupon below and receive your set. Examine books 7 days, with no obligation. Then, if you decide they are the finest, most practical reference set you ever saw, send \$3, and the same amount monthly until total price of \$12 is paid. I'll prepay all shipping charges. Offer is limited. Mail coupon NOW.

H. C. LEWIS, Pres., COYNE ELECTRICAL SCHOOL
500 So. Paulina St. Dept. 33-T4 Chicago, Ill.

HUNDREDS OF PICTURES AND DIAGRAMS! HUNDREDS OF ELECTRICAL SUBJECTS AT YOUR FINGER TIPS!

A few of the many branches of Electricity explained and pictured in this amazing set are:

- | | | |
|------------------|-----------------|----------------|
| Air Conditioning | Refrigeration | Power Plants |
| Telephony | House Wiring | Diesel Engines |
| Auto Electricity | Electric Signs | Motors |
| Talking Pictures | Home Appliances | Armatures |
| Generators | Switchboards | A.C. and D.C. |

*Complete Ready Reference Index of over 2000 listings tells you instantly where to look up any electrical fact.

H. C. LEWIS, Pres.
COYNE ELECTRICAL SCHOOL
500 S. Paulina St., Dept. 33-T4
Chicago, Ill.

NO RISK COUPON

Send me the big 3-volume Coyne Electrical and Radio Encyclopedia, postpaid. Within 7 days after receiving the books, I'll either return them or send you \$3, and \$3 a month until advertised price of \$12.00 is paid.

NAME

ADDRESS

CITY STATE

OCCUPATION AGE

SAVE 10% Send cash price, \$10.80, with order if preferred—you save \$1.20. Same 7-day free trial and return privilege.

JUST OUT! NEW ALLIED 1943 BUYING GUIDE FOR EVERYTHING IN RADIO AND ELECTRONICS



SEND FOR YOURS
...NOW!

The latest streamlined 1943 Catalog of everything in Radio and Electronics. Get all your needs quickly from this ONE dependable central source of supply... over 10,000 items for the Armed Forces, for Radio Training, for Research Laboratories, for War Industries and for Service Replacement. Our large complete stocks speed delivery. Our experienced staff is ready to help you. Send for your new Allied Catalog today... it's FREE!

SEND FOR THESE VALUABLE NEW BOOKS!

RADIO DATA HANDBOOK
No. 37-754

Formulas, charts and technical data
..... 25c



RADIO CIRCUIT HANDBOOK
No. 37-753

Practical data and schematic diagrams. 10c

DICTIONARY OF RADIO TERMS
No. 37-751

Simple definitions of radio terms... 10c



SIMPLIFIED RADIO SERVICING
No. 37-755

Short cuts in trouble-shooting... 10c

WRITE FOR QUANTITY QUOTATIONS

ALLIED RADIO CORP., Dept. 2-C-3
833 W. Jackson Blvd., Chicago, Ill.

Please send following books (....c enclosed)
 FREE No. 37-754 No. 37-751
1943 Catalog No. 37-753 No. 37-755

Name.....

Address.....

City.....State.....

★ ALLIED RADIO ★

SHORT WAVE LISTENERS

Dear Editor:

It has been a good many months since I corresponded with you and I want to take an opportunity of renewing our acquaintance.

Since the war has come to the world, and particularly to our own shores, amateur radio has come to a stalemate, and probably will remain as such until after peace again reigns over the entire world. I have heard from time to time from a few of our observers throughout the world, and all is not well with them. Some time ago I received a letter from a sister of one of them, who lived in Scotland, at the time that he contributed to my page in *Radio & Television*. I had written to him and about a year later my letter was delivered to his parents, and his sister, whose husband is in the British army, took it upon herself to inform me as to our observer's whereabouts. He was a telegrapher in the Royal Navy, and was being transferred from the Isle of Man, where he was stationed when I last heard from him, to the African coast. While at sea, the transport caught fire, and in transferring from one ship to another, the lifeboat in which he was a passenger, capsized, and he was drowned. My letter to him reached his parents just a year to the day from that on which he was lost.

Another one of our contributors was a Frenchman, living in Paris. His brother was owner and operator of a ham station, F8UE. Our observer was on the air often, speaking English for his older brother. The last that I heard of him he was a refugee, fleeing before the oncoming German army. This was just before the fall of France. Since then, I have written three letters, but without receiving a single answer.

I have tried to reach other observers, but as yet have had little results from those outside of our own borders. Now I am going to try again to reach some of those in England, Australia, South Africa, New Zealand, and India. It is my desire to keep

in touch with them if possible, so that some day we may again talk ham radio with one another.

I do not know whether or not you are still publishing *Radio & Television Magazine*. I have not received one in several months, and have been unable to obtain one from the local newsstands. It is hoped that you will be able to continue to publish such a fine magazine. When this mad struggle is over, I would like to again be the editor of a page or two such as I had before. For this reason, I would like to hear from you on this matter. I am sure that some agreement can be made whereby such an article can again appear in such a fine magazine. As a matter of fact, I do not remember as having broken relations with you completely.

Please let me know if it will be possible for me to continue writing for you, with the same type of material as was used before. If you so desire, it may be possible for me to write a few articles before ham radio comes back again. I have some information in regard to our old observers, and could easily gather more. I intend taking it upon myself to write to several of them in the near future, to determine what they have been doing in relation to listening, and the possibilities of obtaining their services as observers after the war.

If this is not possible, please notify me, as I do not wish to mention any magazine space that will not be available to me after the war, and when we can listen to our brother hams from across the big pond. Due to the war conditions, and the shortage of paper and transportation facilities, I will supply my own paper and postage until the end of the war.

May I hear from you soon?

ELMER R. FULLER,
Cortland, N. Y.

(You short wave listeners, from the old days with *Radio & Television*, are you interested in Mr. Fuller's ideas? If so, let us know—Editor)

RADIOMEN ENLIST?

Dear Editor:

In your November issue of *Radio-Craft Magazine* on page 90 there appeared a small item entitled "Radiomen, Listen!"

I am interested in the radio jobs the Government has available. I should like to know if civilians can obtain these radio jobs; also is it necessary to be in the armed services?

I would appreciate it very much if you could give me further literature.

At present I am attending an engineering school. I would like very much to obtain a

Government radio job and do my bit for the war effort.

JOHN LO VERDE,
Fort Wayne, Indiana

(Anyone over 18 may submit their qualifications. If you are in a selective service classification, however, which would indicate that induction may soon occur, it would be advisable to enlist in the Signal Corps. Once enlisted you may choose entering active service immediately or attending a government-sponsored school.—Editor)

ARTICLES ALL HELPFUL

Dear Editor:

As one of your constant readers since your publication started I am writing you that I believe the course of instructive articles for beginners in radio is something that will aid any number of radio servicemen.

I started building radios in 1926 and worked into the radio servicing end until I broke up my home and I entered the Signal Corps for the War Department. I had all but two issues of *Radio-Craft* since it started.

I have found that this publication has filled a direct need and have relied solely

on it as my book of rules for all the latest information.

In my present work I find each issue filled with information that can be used in my work in some form or another.

I assure you that I will continue to rely on it as I have done before.

LAWRENCE M. FAUCETT,
N. Philadelphia, Pa.

(It is gratifying to learn from time to time just how *Radio-Craft* is helping our readers. We hope to always have something worthwhile, even under the handicaps of the war conditions.—Editor)

BASIC OHM'S LAW

Dear Editor:

I recently received my December 1942 issue of *Radio-Craft* and enjoyed reading it very much.

One article in particular attracted my attention, "Electrical Quantities" by Willard Moody. I think this article was well written and contained much valuable information for the experimenter. However I question his definitions of the ampere, the volt and the ohm.

He has based his definitions of all three on Ohm's law. Since Ohm's law is merely a statement of proportion it cannot be used to define all three, or even two, of the quantities involved. Therefore two of the quantities must be defined by other means in order that this relationship may be used to define the third.

I realize the difficulty involved in defining these terms to those having little background in static electricity and electromag-

netism. Even so, I believe the best way to tackle the problem is to present the classical definitions of the units involved and present Ohm's law in its true light. Since the volt and ampere are defined separately in both the absolute electromagnetic and electrostatic systems, we must go back to one of these systems to define the practical units. . . . I hope this letter will help to clear up these units in the minds of the younger readers. I believe a course in electricity and magnetism would make it possible to get more fun out of radio as a hobby.

JAMES J. SHIPMAN,
Akron, Ohio.

(The deleted portion of Mr. Shipman's letter is devoted to his development of the derivation of the Ohm's Law units from the electromagnetic fundamentals. It is very important and highly interesting, and is printed in the back portion of this issue. All earnest students of electricity are urged to read it.—Editor)

BUSINESSLIKE SERVICING SHOP

Dear Editor:

I have been a constant reader of your magazine since its first issue, and of the various Gernsback publications since I began reading the *Electrical Experimenter* about the year 1910, and can appreciate the honor of having my humble shop appear on the pages of *Radio-Craft*.

Our specialty is doing the "impossible." Those jobs, which, for lack of tubes and other components, have been turned down by others. We redesign and return to the customer the same day the job is received, making use of things available instead of worrying about "exact duplicates."

Back of the curtain in the picture is a storage room for completed work. Along the

left wall (not shown) is a complete service and engineering library. All parts and stock, as well as radios not actually being serviced on the bench, are always kept out of sight, in order to make the place more attractive to the feminine clientele.

M. J. EDWARDS,
Radio Hospital,
Shreveport, La.

(We liked the appearance of his shop so well we decided to feature it here in the Mailbag section where it would be spotted first. It has been some time since we featured our readers' shops and several have written in asking that we run these more often. We are always glad to have them—how about yours?—Editor)

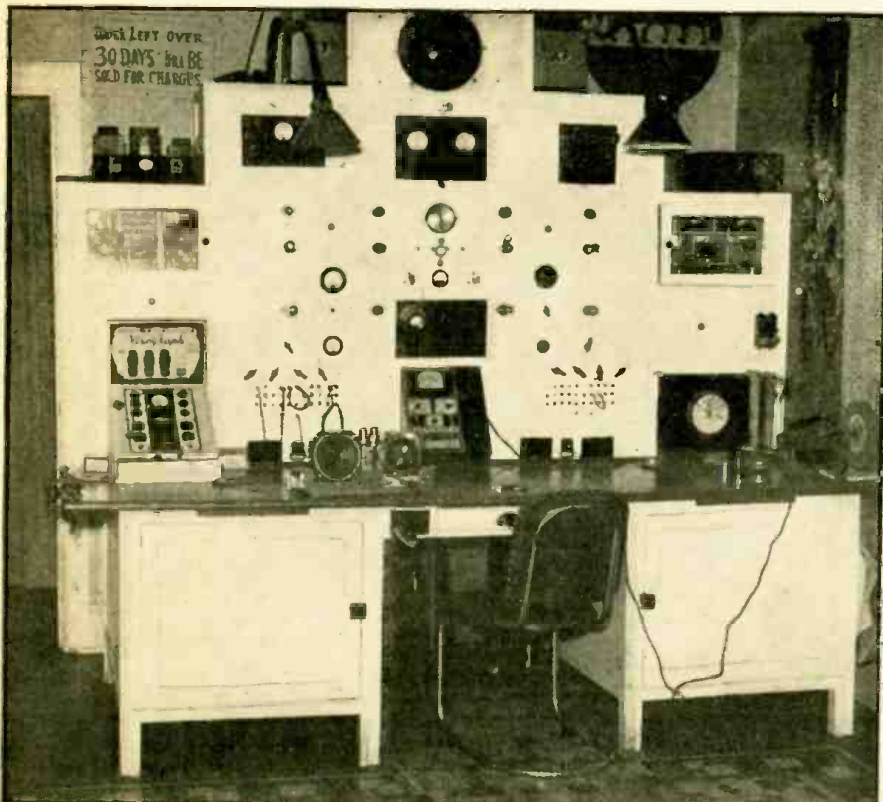

The neat compact businesslike appearance of Mr. Edwards' radio repair shop has appeal for all eyes. Mr. Edwards, who is a graduate of M.I.T., has been in the radio field for many years, specializing in photo-electric and electronic devices. His thorough technical knowledge and his sound business methods have been factors in his success.

CODE MACHINES
—You can buy one!

We have 35 reconditioned *McElroy* 1941 model code machines, all electric, photo-electric type which we are offering for sale. This is an excellent piece of equipment and one of these machines will give you years of dependable service. Original price of code machine complete with variable speed tapepuller was \$96.00 net. You can now buy one of these machines complete for only \$40.00. Delivery is immediate. Only thirty five machines are available, act at once.

AYERS AUTOMATIC CODE MACHINES
711 Boylston St., Boston, Mass.

MEN AND WOMEN
AIRCRAFT RADIO COMMUNICATIONS COURSE

Specialist training for those planning to enter WAVES, WAACS, Army, Navy, Merchant Marine or private industry. Radio telephone, Radio telegraph, Radio Code, complete preparation for FCC license examinations. Learn in Miami!

Write or wire
Embry-Riddle School of Aviation
3240 N.W. 27TH AVENUE
MIAMI, FLORIDA

LEARN CODE the way you'll be using it by **SOUND**



The best way to learn to read code is by listening to code. The best way to learn to send code is by hearing your own sending repeated back to you. With the new All-Electric Master Telex Code Teaching Machine, you learn code the natural, easy, fascinating way. Only instrument ever produced which records your sending in visible dots and dashes—then SENDS BACK your own key work at any speed you desire. There are NO PERFORATIONS—NO INK. Far superior to anything ever developed—a marvel of simplicity. That's why practically every school teaching code uses TELEPLEX. We furnish complete course, including the All-Electric Master Telex, give you personal instruction with a MONEY BACK GUARANTEE—all at a surprisingly low cost. Write today for FREE catalog S3. No obligation.

TELEPLEX CO., 107 HUDSON ST. JERSEY CITY, N. J.

USED Correspondence Courses

COMPLETE HOME-STUDY COURSES and self-instruction books, slightly used. Sold, rented, exchanged. All subjects. Satisfaction guaranteed. Cash paid for used courses. Full details and 84-page illustrated bargain catalog FREE. Write today! NELSON COMPANY, 500 Sherman, Dept. C-210, Chicago

The SPRAGUE TRADING POST

EXCHANGE — BUY — SELL

VOLT-OHMMETER WANTED—prefer a Triplett. Must measure to 3 megs. resistance and 500 volts. Would like a mil. scale, too. T. Rex Phelps, 3717½ Canal St., Houston, Texas.

WILL SELL—HALF PRICE—official Radio Service Manual Vol. VI. Battery operated Philco Signal Generator; also Radio City Products Tube Tester, good for beginners. Friek Radio Service, 1311 W. Virginia St., Evansville, Indiana.

WANTED—Oscillograph, also obsolete radio test equipment, and used sound heads for 35 mm. film: Alfred L. Lepore, 736 Manton Ave., Providence, R. I.

WANTED—any kind of test equipment at reasonable prices—also any odd meters you might have available. Give list of same and price. Rolan P. Woods, CEM, Training Center Force, U.S.N.C.T.C. S-3, Camp Endicott, Davis Ville, R. I.

CASH FOR MANUALS—Will pay cash for complete set of Rider's Perpetual Trouble Shooters Manuals, or will buy separate volumes. Must be perfect, and priced right. Kirkby Radio Service, 464 River St., Manistee, Michigan.

WANTED—Tube checker. Multi-Tester, Oscilloscope, Signal Tracer, Condenser Tester, Rider's Manuals from 8 to 13. Will pay cash or swap sound equipment, amplifiers, mikes, etc. State price in first letter. Norman Jacobson, 1117 Gerard Ave., Bronx, New York, N. Y.

TUBE TESTER FOR SALE—or trade. JMP Tube Tester, also RCA 204A Xmitting Tube, and Jewell Type 54 0-15 d.c. mill. meter. Want Jefferson or Thordarson 60 watt 6L6 P.A. or parts for same. Snavely Radio Shop, 1014 Cedar St., Elkhart, Indiana.

WANTED—25, 50, or 100M ohm bleeder resistances, not less than 25 watts. Prefer semi-variable type. Leonard Cole, 266 Delmar Rd., Rochester, N. Y.

MANUALS WANTED—Rider's Nos. 1, 2, 3, 4, 5, 8, 10, 11, and 13. Also want inductance bridge and an H.T.-7 or equivalent. Henry Wagner, 4411 Indianapolis Bld., East Chicago, Indiana.

WANTED—Receiving parts, tubes, meters, power transformers, relays, condensers, speakers, and variable and fixed resistors. Give cond. and best price. Will trade new Lionel 00 scale model train outfit No. 0082-W with whistle and track freight engine, tender, box car, oilcar and caboose. R. N. Eubank, Room 504, Virginia Electric & Power Co., Richmond, Va.

TUBES FOR SALE—1, 5E1; 1, 1B7G; 1, 2Z2/G84; 2, 6AF5G; 1, 6H4GT; 3, 6K5GT; 1, 6ZY5G; 2, 14A7/12B7; 1, 182B; 1, 183; and 4, 2A7S. Reliable Motor Parts, Inc., 1709 Seventh Ave., Beaver Falls, Pa.

WILL TRADE RECORDING UNITS—Two brand new units, Majetic motor, cutting head, playback, complete. Separate amplifier makes a home recorder. Will trade for manuals, equipment, or what have you—radio or otherwise? M. J. Mensinger, c/o Radio Dept., 4551 Sheridan Rd., Chicago, Ill.

RADIOS WANTED FOR CASH—Will buy for cash new radios and combinations. Any kind or make, small or large quantity. Acme Radio Co., 5126 Santa Monica Blvd., Los Angeles, Cal.

RECORD CHANGER WANTED—Capehart, late model preferred. Also volt-ohms-mils tester, any make but must be perfect. International Radio Stores, 232 Sherman Ave., New York, N. Y.

INSTRUMENTS WANTED—Volt-Ohmyst, Chanalyst, Volt-ohm Meters, Tube Testers and 6AC7/1852 tubes wanted. State prices, make and year of manufacture. Tubes must be in original cartons. William Platt, 710 Broadway, Schenectady, N. Y.

WANTED—What have you in the line of tubes, parts, shop equipment, and Rider's Manuals Nos. 7 to 13? Huntington Ave. Tire & Battery Service, 766 Huntington Ave., Boston, Mass.

A WARTIME SERVICE TO THE RADIO PROFESSION

Is there something pertaining to Radio that you want to Buy—Sell—or Swap? If so, send us your advertisement today. We'll schedule it for appearance in the Sprague Trading Post as soon as possible—**AT NO COST TO YOU**, and providing only that it seems to us to fit in with the Trading Post plan. Our aim is to cooperate with our friends throughout the trade with the object of helping keep the nation's radios working during these shortages of wartime days! Address your ad to: **SPRAGUE PRODUCTS COMPANY, North Adams, Mass.**

Your Own Ad Run FREE!

WILL TRADE—Have plenty of used 26, 27, 24, and 01 tubes to trade for popular types—also 6 ohm rheostats for what have you? Colonial Radio Lab., 1714 Forest Ave., Dallas, Texas.

WILL TRADE—complete 1941 G-E 8-tube table model radio with F-M band only, 39.5 to 45. megs. Very good condition. Want Rider's Manuals, Marlin rifle model 39, or what have you? Rene Schwartz, 141 Bullard St., New Bedford, Mass.

WANTED—Dead V.O.M. and tube checkers. Meters either good or bad. Also want hi-powered binoculars and microscope. State full details including lowest price. Anthony Pusateri, 1101 Fleming St., Coraopolis, Pa.

WANTED—Radio tubes and parts for a.c.-d.c. radios. Also want small radio sets, new or used. Merrit Radio Shop, 3908 Sunset Blvd., Los Angeles, Cal.

INSTRUMENTS WANTED—Signal generator and oscillograph, good makes. Give full details and lowest cash prices. Peters Music Shop, 1719 Mass. Ave., Lexington, Mass.

INSTRUMENTS FOR SALE—Rider Chanalyst, \$100. Solar Condenser Analyzer, \$20. Good condition. Also Rider's Manuals, vols. 1 to 12, 25¢ off. Clark Ross, 2373 Kiesel Ave., Ogden, Utah.

METERS FOR SALE—Have twenty 0-10 mill. D'Arsonval type; 2¼" face, 3¼" O.D., moving coil, \$3 each. Also have 300 assorted meters, iron vane type, 25¢ ea. or make offer. Want 16 mm. projector. Jack's Radio & Music Shop, 14 Bellingham St., Chelsea, Mass.

FOR SALE—100 tubes of various types, also condensers and transformers. Would like to swap a tube tester for a new one, and have some used radios (late models) for sale in good condition. L. W. Coleman, 29 Wellesley Drive, Pleasant Ridge, Mich.

TUBE TESTER FOR SALE—Hickok AC-51, just modernized, \$50. Would like 5" Oscilloscope. Describe fully. Also want Hickok Vac. Tube Voltmeter, good slide rule, and good camera. E. M. Prentke, 1960 East 105th St., Cleveland, Ohio.

THE CONDENSER YOU NEED... when you need it!

Sprague Atom midget dry electrolytics are still available—and with them, you can handle practically any condenser replacement up to their ratings. You can get Atoms in single-sections as well as in multi-capacity units—and you can make up hard-to-get replacements by strapping individual Atoms together. Atoms are smaller, cheaper, and fully as reliable as the big, old-fashioned condensers they replace. Use Atoms **UNIVERSALLY** on all of your jobs!

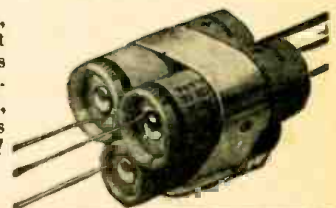

SPRAGUE PRODUCTS CO.
North Adams, Mass.

SPRAGUE CONDENSERS AND KOOLOHM RESISTORS

Obviously, Sprague cannot assume any responsibility for, or guarantee goods, etc., which might be sold or exchanged through above classified advertisements.

RADIO-CRAFT

Incorporating

RADIO & TELEVISION

“RADIO'S GREATEST MAGAZINE”

. . . *Super-Electronics*
is the key to man's future
advancement . . .

SUPER- ELECTRONICS

By the Editor — HUGO GERNSBACK

THE triumphant march of electronics, particularly in industry during the past few years, is likely to be totally eclipsed in the immediate post-war future. At present the art of electronics is being used in every conceivable manner to lighten man's burdens and to speed up thousands of processes in ways not thought possible even a decade ago.

But we are only at the very beginning of the art, with new discoveries which will stagger the imagination, due to come about in the near future.

In coining a new term—*Super-Electronics*—I would like to point out that it might well apply, not so much to industrial electronics, but rather to vastly expand man's mediocre senses in the world in which he lives.

All of our senses, when considered from a purely scientific viewpoint, are most imperfect. We usually speak of our five senses; namely: Sight, Touch, Hearing, Scent, Taste. All of them are relatively poor. Our sight covers only a certain short range;—thus we cannot see beyond the light spectrum. We are blind to the ultra-violet and infra-red and what lies beyond both of them.

Our hearing, even compared to that of a dog or canary, is exceedingly mediocre. Beyond a certain frequency we are totally deaf, yet a dog or canary hears sounds of which we are not aware. It is the same with our other senses.

Here super-electronics will put man into intimate touch with the surrounding universe. Super-electronics will open up undreamed of worlds in this sphere which we can only dimly sense today.

Thus, for instance, super-electronics will bring a new type of music to us which the normal ear could never hear. It will bring sight into the infinitely small on the one hand and into the infinitely remote outposts of our own universe, on the other. Already the electron microscope has given us sight far beyond the most powerful microscope. Soon we may see suns and other worlds millions of light years removed from us, which cannot even be seen by the most sensitive photographic plate today.

Our bad sense of touch will be greatly assisted by super-electronics. The crude surgery methods of today will be replaced by something infinitely superior. The surgeon of the future will be enabled to mend nerves which have been severed, and thus restore useless limbs. It is the same with our senses of scent and taste. Super-electronics will do our tasting for us at food and packing plants to make sure that the quality of all food is the same without

variation. Entirely new food combinations will result, once super-electronics replaces our present “taste-and-try” methods of cookery. The same may be said for such products as wines and liquors, which will be made infinitely superior and more uniform by super-electronics.

Paralleling this, we will have notable advances in scent. Food, perfumes and the like all will be vastly improved, and there will be new combinations in scent impossible to even imagine now. Coupled with this, the medical arts will be vastly enriched by tracing to its lair whatever it is that gives us colds or pneumonia along with the rest of the germ diseases carried in the air which we inhale through the nose and mouth.

There are, however, other senses usually not recognized,—all of which are about to be investigated by super-electronics. There is, for instance, the homing sense of the carrier pigeon. We already know that it is affected by radio waves. Soon we will know exactly what it is that makes this sense possible. In man, the sense of direction is probably linked in some way with the homing sense of the pigeon.

Then we have, what I may call, the barometric sense. People who have rheumatism or who have undergone an operation have this sense highly sharpened. They generally can predict the coming of storms, rain or snow. So far there has been no satisfactory explanation for this, but we may be certain that super-electronics will find the solution; and if it does, there probably will be suitable remedies for this particular type of torture.

That man has a well-defined time-sense is well known. I first spoke editorially about this in the September 1922 issue of *SCIENCE & INVENTION*. Any one who must get up at, say 5 o'clock on a certain morning (which he is not accustomed to)—without an alarm clock,—knows what this time-sense is, but what makes it, no one knows. Then we have the sense of Extra-sensory Perception, (telepathy), now pretty well established, due primarily to the indefatigable work of Professor Joseph B. Rhine of Duke University. His researches have shown that the existence of telepathy can no longer be brushed aside as pseudo-science. It is certain that these two as yet most elusive senses, will soon come into the physical realm, thanks to super-electronics.

Once all of our senses have been brought to a high state of development through the medium of super-electronics, man will then indeed have arrived on a plane that will make life far more tolerable and enjoyable than what it is now.

A Digest of News Events of Interest to the Radio Craftsman

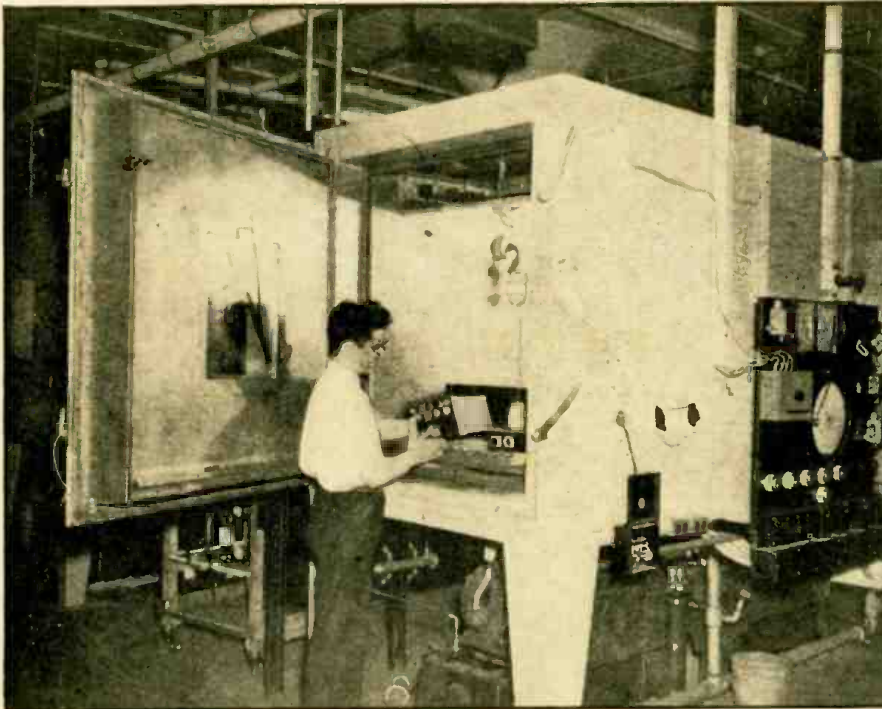

Radio receivers for the armed forces given the third degree. In order that valuable equipment won't fail in the tropics or in the arctic regions, or on the sea, RCA aircraft receivers are tested in these chambers at temperatures of 152 degrees and down to 22 degrees below zero, and are subjected to all gradations of moisture as ordinarily found in the different temperature zones.

TUBE PRODUCTION

The WPB has released the following list of receiving type tubes, as those being scheduled for production during the first three months of 1943.

It will be noticed that metal tubes have been omitted. The metal-glass equivalents are listed, and the serviceman must be prepared to make the necessary socket and shielding adjustments when using these tubes to replace the metal types.

This list is not to be construed as being 100% with all manufacturers. Depending on what materials and facilities are available, the tubes in this list will be produced in different quantities by each manufacturer. In other words some manufacturers may produce suitable quantities of all tubes, others will produce only part of those listed.

At least this is a step toward easing the tube situation, and should give some comfort and assistance to those who are responsible for maintaining receivers in up-to-date operating condition.

OZ4	1LD5	2A5
1A5 GT/G	1LE3	3Q5 GT/G
1A7 GT/G	1LH4	5U4 G
1C5 GT/G	1LN5	5V4 G
1H5 GT/G	1N5 GT/G	5X4 G
1LA4	1P5 GT/G	5Y3 GT/G
1LB4	1Q5 GT/G	5Y4 G
1LC6	1V	5Z3

6A7	7A4	35
6A8 GT	7A6	35A5
6B7	7A8	35L6 GT/G
6B8 G	7B5	35Z3
6C5 GT	7B7	35Z5 GT/G
6C8 G	7C5	36
6F5 GT	7C6	37
6F5 GT	7C7	38
6F6 G	7F7	39/44
6F8 G	7H7	41
6H6 GT	7J7	42
6J5 GT	7N7	43
6J7 GT	7V7	45
6K5 GT/G	7Y4	47
6K6 GT/G	12A8 GT	50L6 GT
6K7 GT/G	12J5 GT	50Y6 GT
6K8 GT/G	12K7 GT/G	56
6L6 G	12Q7 GT/G	57
6L7 G	12SA7 GT/G	58
6N7 G	12S7 GT/G	70L7 GT
6Q7 GT/G	12SK7 GT/G	71A
6R7 GT/G	12SQ7 GT/G	75
6SA7 GT/G	14A7/12B7	76
6SC7	24A	77
6SD7 GT	25L6 GT/G	78
6SJ7 GT	25Z5	80
6SK7 GT/G	25Z6 GT/G	83
6SQ7 GT/G	26	84/6Z4
6V5/6G5	27	117L7 GT
6V6 GT/G	30	117Z6 GT
6X5 GT/G	34	

CARRIER CURRENT EQUIPMENT

Developed in the G-E Carrier-current Laboratory prior to the present war, the carrier-current equipment used at the military bases is similar to that used by many electric power stations to control street lights and water heaters.

The equipment transmits impulses over the regular power lines at the military bases. These impulses are picked up by receivers

which in turn operate relays to turn on or off the current flowing to electric lights, pumps, and other electrical apparatus. Use of this equipment at the military bases eliminated the necessity of running many miles of separate lines of copper cable to control the various electrical circuits.

Savings, as high as 85% have been achieved by using this equipment.

ENGINEERING CADETTE TO STUDY AT PURDUE

A comprehensive program designed to turn out trained women radio technicians will be undertaken by the RCA Victor Division it was announced last month by R.C.A.

This will be the first girl's training school of its kind in the electronics field. These engineering cadettes will earn as they learn, at Purdue University. Classes will begin around May 1st, with a group of about 100 girls, between the ages of 18 and 22. They will be selected from the company's own plants and from colleges and universities. Basic requirements call for two years of college study with satisfactory grades, some competence in mathematics, good health, and an interest in technical radio work.

The curriculum provides for two terms of 22 weeks each. The cadettes will be given courses of study designed especially to qualify them for immediate assignment on test and quality control work on the electronic, sound, and radio equipment which R.C.A. is building for the armed forces. The intensive schedule calls for 40 hours per week of classroom work or supervised study.

BOARDWALK HAVEN

So that the thousands of men in the armed services in Atlantic City and nearby may have a place to meet their friends and relatives, and spend their leisure time, Philco Corporation has opened "Philco House" on Central Pier on the Boardwalk in Atlantic City. More than 2500 servicemen thronged it during the first two days it was open.

A spacious lounge with writing facilities, telephone and telegraph service, and a library are being provided for the servicemen, large numbers of whom will go directly from Atlantic City to overseas duty.

One of the features is a collection of popular books which the soldiers may read or take with them, if desired. Every person connected with the company is being given the opportunity to present one or more books to the library. It is expected that as the soldiers move on to foreign duty, some of these books, containing names of former owners, will turn up in Africa, Australia, and other remote places where fighting is in progress.

TELEVISION INSTRUCTION FOR AIR RAID WARDENS

Civilian defense officials of Schenectady County have established seven official television posts throughout the county for the instruction of air raid wardens via television. Programs are received by television receivers loaned to Schenectady defense officials by the General Electric Company.

Programs originated by NBC's television station WNBT, in New York, are picked up by a television relay station (the first of its kind) located in the Helderberg Mountains near Schenectady. This station relays the programs to television station WRGB which rebroadcasts them for the wardens.

Prior to the establishment of the definite television posts, the air raid wardens were receiving part of their instructions through the courtesy of television-receiver owners who invited the wardens in for the WNBT-WRGB programs.

Five of the new television posts are strategically located fire stations, one in a town hall, and one at Union College in Schenectady. Over 2000 air raid wardens attend the lessons via television, after which they listen to lectures and have question-and-answer periods.

POST WAR RADIO AND ELECTRONICS

In a plea for an American charter for American business after the war, David Sarnoff, President of R.C.A., recently told a meeting of business men that the great hope for American prosperity and security in the post-war period lies in the cooperation of the government with industry, labor and agriculture.

"Our hope for a future world economy of abundance is founded upon much more than pre-war standards of prosperity," said Mr. Sarnoff. "It is based upon the promise of industrial science. The old frontiers of the world were frontiers of geography. The new frontiers are those of science. The covered wagon of the present day is the research laboratory.

"Progress in the field of radio and electronics has advanced on the same broad front with progress in other fields of science and industry. It is radio which has made possible a war of speed and mobility on land, at sea and in the air. Radio-electronic sentinels stand watch on shipboard and along the coast. The United States now has fighting forces stationed at more than sixty strategic locations on the world map. Its Navy operates on the Seven Seas. Without instant, reliable radio communication it would be impossible for these wide-spread forces to function as a unified war machine."

Referring to the radio tube as the heart of every radio instrument, Mr. Sarnoff said that science in putting electrons to work in the tubes has greatly extended the usefulness of electronics in industry as well as in communications.

"We began learning how to control the elusive electrons in vacuum tubes, forty years ago," he said. "The versatility of these tubes, and of the devices built around them, is amazing. They can be made to respond to light, to all shades of color, to smoke, to the faintest noise. In terms of results, we can say that they are able to hear, see, feel, taste, remember, calculate and even talk. They bring increased speed, accuracy and safety to a wide variety of industrial operations."

Calling attention to the latest radio-electronic developments, Mr. Sarnoff appraised the electron microscope as an outstanding achievement. Capable of magnifying 100,000 diameters, it has opened new worlds of knowledge in biology, bacteriology, medicine, physics, chemistry, plastics, textiles and other fields of research.

"In most industries," he said, "the emphasis is on bigness. Radio science is built on minuteness. An electron is a tiny fraction of an atom."

To illustrate this point he called attention to the fact that the electron microscope made it possible to photograph the influenza virus for the first time. It should not be forgotten, he added, that a single invisible germ sometimes carries more power of destruction than a 2,000-pound bomb.

Describing television as "the most spectacular development in the field of communication," which may be looked forward to in the post-war period, Mr. Sarnoff predicted that when the war is over, television will advance as a new service of public information and entertainment.

"We expect to have inter-city networks of stations as we have them in sound broadcasting," he revealed. "Eventually they will become nationwide. We look forward to television programs in theatres as well as in homes. Thanks to war research, these television pictures will be technically much better than they were before, and used on a much wider scale.

DEVELOPS RAPID RADIO TESTER

(COVER FEATURE)

To speed up the delivery of fighting planes Edwin C. Tracy of RCA Victor Division developed the radio-electronic device shown, which tests radio installations in a matter of three minutes, as compared to the old laborious method which took eight man-hours of work.

Mr. Tracy, an installation and service

in his station, including the receivers. As he progressed he specialized in directive antennae and experiments in U.H.F. work.

Tracy's suggestion grew out of the need for speeding up the testing of aircraft radio equipment. Formerly, before a plane went into action, it was necessary to disconnect all or nearly all the radio equipment, remove

Edwin C. Tracy of the RCA Victor Division receiving the WPB citation from President Roosevelt, along with five other men who rated citations for individual production merit. Tracy developed the radio-electronic device that speeds up testing of plane radio installations. What used to take eight man-hours is now done in three minutes.



engineer, started with Victor two years before Pearl Harbor. His father was a missionary in Turkey, and he was born in that country. While still a youngster he caught what was then known as the "radio bug" and did so well with it that by the time he was 18 he obtained his "ham" license.

From the start Tracy spurned ready-made material and built all the equipment

it from the plane, set it up in the testing equipment and put it through tests. This required an average of eight man-hours per plane.

A relatively simple oscillator was devised by Tracy. It is set up in the airfield and gets the same or better results in three minutes. These oscillators are now installed on almost every American flying field.

RADIO INTERCEPTORS NEEDED

PERSONS qualified to intercept radio messages are needed by the Federal Communications Commission, the Civil Service Commission announced last month. The positions pay \$2,000 and \$2,600 a year, plus overtime, which increases the salaries about 21% for 8 hours of overtime a week.

Radio intercept officers will participate with Army Air Forces in effecting radio silence and insuring compliance with silence orders, tests the efficiency of methods of control, maintain a continuous watch on distress channels, and otherwise participate in monitoring assignments relating directly to the war effort.

For assistant radio intercept officer, \$2,600 a year, persons must have had either a full 4-year course in electrical engineering or physics at a college or university of recognized standing, 4 years of technical experience in the field of radio, or a time-equivalent combination of such education and experience. For the \$2,000 grade, less

education and experience is required. Applicants for both grades must be able to transmit and receive in International Morse Code, and in some cases may substitute experience as a radiotelegraph operator, or as an amateur holding a Class A license, or radio and engineering study at a recognized college or radio institute for part of the prescribed education or experience.

No written test is required, and the only age limitation is that applicants must have reached their eighteenth birthday. Positions are to be filled throughout the United States.

Persons using their highest skills in war work are not encouraged to apply. War Manpower restrictions on Federal appointments are given in Form 3989, posted in first and second-class post offices.

Complete information and application forms may also be obtained at these post offices, as well as from civil service regional offices and from the Commission at Washington, D. C.

POPULAR ELECTRONICS*

By RAYMOND FRANCIS YATES

PART II

THE student who would grasp the fundamentals of electronics would do well to confine his attention to the matter of electric charges.

Lying at the base of all electric or electronic phenomena is the fact that we have one of three electric conditions associated

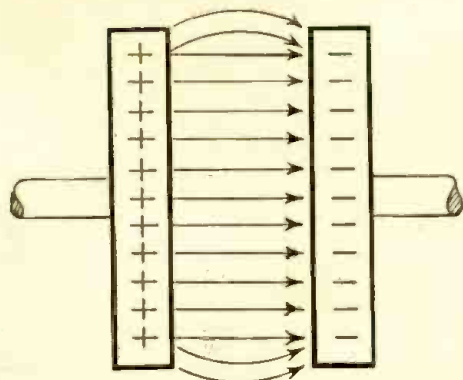

FIG. 1

The lines indicate the electric field set up between two charged bodies.

with matter. It makes little difference where we are; in the jungles, in the air, under the surface of the earth, in heat or in cold; the things around us are either electrically neutral or they bear what is known as a *positive* or a *negative* charge.

Some of these charges are so slight as to make it impossible to detect them, even with the most sensitive and responsive instruments. Other charges, such as those in the higher atmosphere, accumulate to such a degree that discharges two or three miles long take place, quite suddenly and explosively. We call these discharges: "lightning."

ELECTRICAL CHARGES

If our eyes were sensitive to electric effects, we would be able to see many interesting and unsuspected things. Most things with which we deal are constantly in a more or less electrically agitated condition; that is, they are either positively or negatively

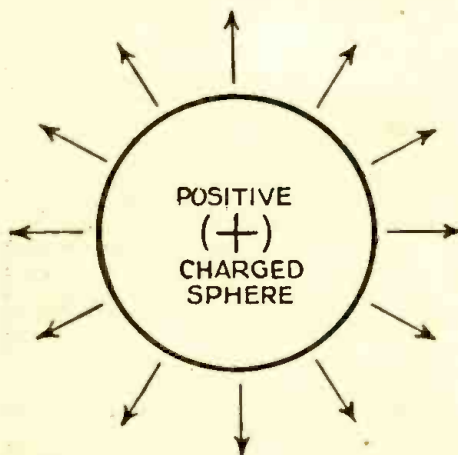

FIG. 2

In the case of a charged sphere, the electric field extends equally in all directions.

charged. We cannot strike a match, cut a piece of paper, polish furniture, walk on a carpet or even breathe, without in some small way affecting the electrical charges distributed throughout our immediate environment. The electricity in the world is in a constantly changing state, leaving one place and accumulating in another.

The things about us and beyond us, indeed all things, are either neutral electrically or they are positive or negative. They are not, however, positive, negative or neutral in a lasting sense. That which is neutral this instant, may be electrically positive or negative in the next instant, and a body carrying a positive charge, may, under the proper conditions, be changed to negative in the ten-thousandth part of a second. There is rarely any permanency to such conditions and oftentimes the most elaborate precautions have to be taken to electrically isolate a charged body in a way to preserve its charge.

BEHAVIOR OF CHARGES

The behavior of these charges, positive and negative, toward each other, is important, for upon this behavior rests a great deal of our electrical theory. Fortunately, this behavior is relatively simple and the action of electric charges under precise conditions is always predictable. When two

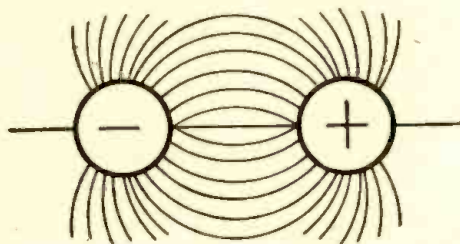

FIG. 3

When oppositely charged spheres are brought together, the lines of force in the electric field created take the form shown.

negatively charged bodies are brought into close relationship, they repel each other. The same holds for positively charged bodies. Hence, we may set it down as an unchangeable rule that like charges of electricity repel each other. Not so with unlike charges. These attract each other. Unless we firmly anchor these two facts in mind NOW, we might just as well abandon all further thought of studying the subject of electronics, for many of the things that we shall be trying to learn will be unintelligible without these basic concepts. (See Figs. 1, 2 and 3.)

Perhaps the formulation of two rules would help. One states that like charges always *repel* each other. The other that unlike charges always *attract* each other.

VERIFY BY EXPERIMENT

The student of electronics is strongly urged to verify what has been, and what will be, said by experimental demonstrations of his own. Only common household materials will be needed and he will find himself engaged in many exciting adventures,

when he repeats experiments that were conducted by the early masters such as Gilbert, Boyle (who was the first to use the word "electricity"), and Guericke. Indeed it is to be regretted that so many home students of electricity (and of science in general), fail to indulge in the production of "static" or "frictional electricity." It was the first faltering experiments with this that laid the foundation for the electrical arts as we know them today.

USE SIMPLE MATERIALS

A piece of sealing wax, a silk handkerchief and a few bits of dry paper are all that are needed for the first experiment. The sealing wax is rubbed briskly with the dry handkerchief. Thereafter it will attract the bits of paper and hold them. Curious? It is more than curious. It is still one of the great wonders of our day!

More wonderful still is the experiment wherein a tiny bit of cork is suspended from a shelf by means of a dry silk thread. The sealing wax is again "excited" with the handkerchief, and one end is brought near the cork. Mysterious, invisible talons grasp the cork and violently pull it toward the wax stick.

Still more wonders! We lay two pieces of sealing wax on a table and sprinkle tiny bits of paper between them. Now a dry piece of window glass is placed on the sticks and rubbed briskly with the handkerchief. Lo and behold, the pieces of paper defy gravity and fly to the bottom of the charged glass.

The observing experimenter will notice that his bits of paper do not remain adhered either to the wax stick or to the glass sheet. Soon they are repelled and fall away. We can well imagine how mystifying these capers must have been to the early workers. Indeed they are still mystifying—at least Dr. Albert Einstein thinks so, and a great

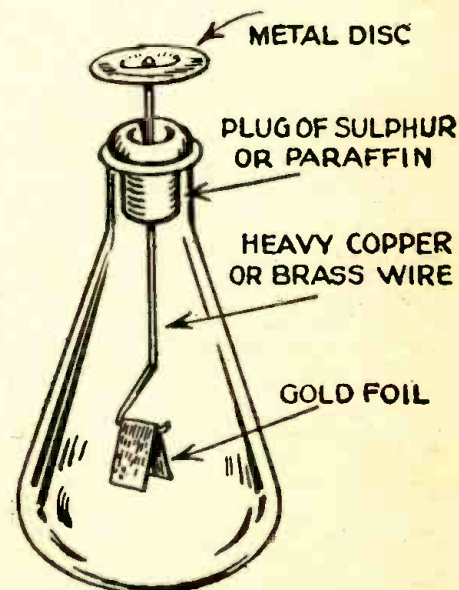

FIG. 4

The constructional details of a home-made electroscope.

*Application for Trade Mark Title, pending in U. S. Patent Office.

amount of his mathematics have been devoted to the very things that we have been discussing. Dr. Einstein still thinks such things are interesting, even though Johnny Jones, the would-be electronist, does not.

We get a tiny fluffy feather off the pet canary. We heat gently to dry it and it is then tied to a skein of fine silk thread, undyed if possible. The feather is then suspended from a shelf by means of the thread and we approach it with the end of a glass rod that has just been vigorously rubbed with a dry silk handkerchief. The feather will make a quick, lifelike lunge to the rod. Remaining there for a moment, it will as quickly depart and thereafter the rod will repel, rather than attract, the feather.

Now if a finger be used in place of the glass rod, the feather will again fly forward and repeat the action. What has happened?

Obviously, the bits of paper and the feather became electrified by contact with the same kind of electricity as that carried by the glass or wax rod. Like charges repel each other, so immediately they shared the charge, and took on their electrical career. It was clear that the feather retained its charge, and in turn imparted it to the body, when it flew to the finger.

NEUTRALITY

Let us repeat: Like charges repel, unlike charges attract.

It is quite impossible to produce one kind of electrification without the other. Proof of this lies in the electrification of two bodies according to directions previously given, and imparting this charge to a third body. The result is unqualified neutrality.

When two electrified bodies are brought near each other without touching, a marvelous condition is established. We have already learned that such bodies attract each other; but that is not all. The space between the bodies is filled with what is known as an electric or electrostatic field. This appears to amount to a form of strain or stress and it is imagined, largely for purposes of convenience, to have invisible "lines of force." At any rate, we know that it is there. Indeed an ingeniously devised experiment demonstrates this beyond all question of doubt. A properly suspended fibre or thread of glass placed between two

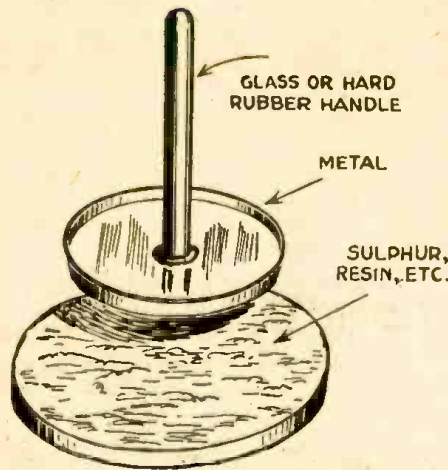

FIG. 5

Fig. 5 shows the simple elements of an electrophorus, and the nature of the distributed charges.

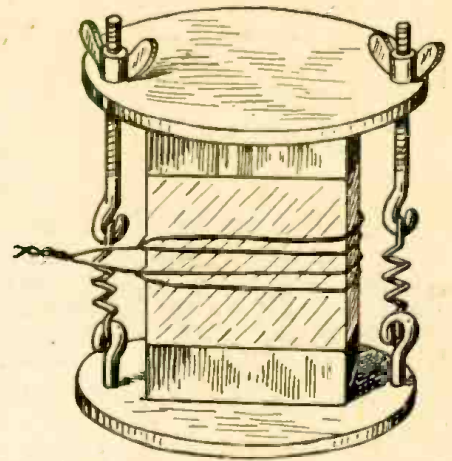

FIG. 6

Fig. 6 shows a crystal of Rochelle Salts placed between clamps. As the winged nuts are tightened, even slightly, the charge set up in the crystals increases.

oppositely electrified bodies will tend to point across the field in the direction taken by the lines of electrostatic force, the glass always swinging from the positive surface.

THE ELECTROSCOPE

Every student of electronics will want to make himself an electroscope. With it he will be able to show that few things that we do in our daily routine fail to build up and tear down electric charges. The electroscope is of the gold-leaf type, and the directions supplied in the drawing should be sufficient for its construction. Perhaps warming it gently each time it is used will help make it more sensitive. Dampness of any kind supplies conducting surfaces and defeats experiments in electrostatic phenomena.

The gold leaf used on the instrument is the sort used by sign painters, and is extremely difficult to handle; therefore the assistance of a local sign painter may be sought in mounting the leaves. (See Fig. 4.)

This instrument has an uncanny sensitivity. When a glass, rubber or wax rod is rubbed with silk or wool, and brought within two or three feet of the instrument, the tiny gold leaves will fly apart. Why? Apparently through some sort of mysterious action that takes place in the space (not the air) between the rod and the 'scope. At any rate, the two leaves become electrified with the same charge as that carried by the rod and they therefore repel each other.

The amazing sensitivity of this little device is beautifully demonstrated when the brass disc at the top of the brass rod is gently stroked with a small camel's hair brush. This will generate a certain amount of electricity by friction and the gold leaves will tend to diverge.

That a certain amount of electrification

takes place by cleavage can be demonstrated by cutting tiny bits of paper with scissors and permitting them to drop on the brass disc. Again, the leaves will move. Pencil sharpenings will do the same thing.

Years ago, Coulomb demonstrated that the force exerted between electrified bodies follows the law of inverse squares. In short, when two bodies exert a certain force when separated by one inch, that force, whatever it is, is reduced to one-quarter of its original value, when the distance is increased to two inches.

A separation of 10 inches will reduce the attraction or repulsion to 1/100th of the original value.

Small charged bodies exert very little influence on each other over comparatively small distances. However, when bearing heavy charges, and when separated by very small distances, electric charges of the kind we have been discussing may actually leap across space in the form of an electric spark. This can be dramatically demonstrated by the aid of an electrophorus, which was devised by the great Volta in 1775, and which we should by all means make.

THE ELECTROPHORUS

The thing takes the form of a cake or disc (about 5 to 12 inches in diameter) of resinous material and a round disc of metal slightly smaller which may be cut from the bottom of an ordinary tin can. Sealing wax, shellac or resin may be used to cast the cake. Sulphur, too, may be used. (See Fig. 5.)

The cake of the electrophorus is laid on a table, and rubbed briskly with a dry warm woolen cloth. Now the metal disc is placed on the freshly rubbed surface of the cake, and the finger of the operator is momentarily

(Continued on following page)



Left—The home-made electroscope in use. When a piece of ordinary sealing wax is rubbed with a silk handkerchief, the leaves of the electroscope will diverge when the end of the wax is brought near. Right—A spark being drawn to the knuckle from a home-made electrophorus.



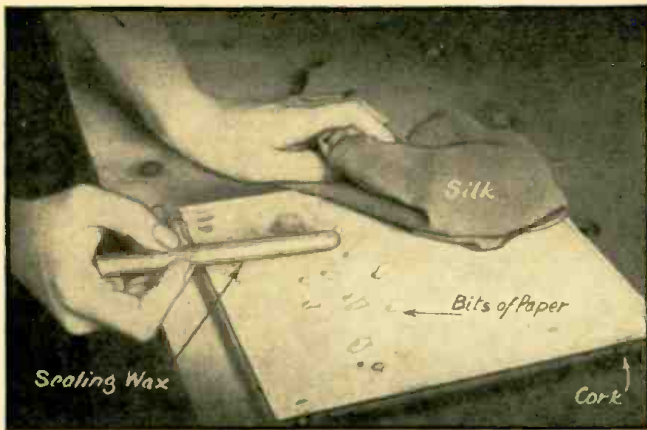

The photo at the left shows a piece of sealing wax attracting small bits of paper after it has been charged by being rubbed with a piece of silk. The photo at the right shows a few bits of paper placed in the lid of a can underneath a piece of dry window glass. When the glass is rubbed briskly with a piece of silk, the pieces of paper will fly to the under surface of the glass and adhere.

(Continued from previous page)
 touched to the metal disc. Now the disc is lifted from the surface of the cake by the aid of the glass handle and the knuckle of the opposite hand is brought to within a short distance (say $\frac{1}{8}$ inch) of the edge of the metal. An electric spark will instantly jump between the knuckle and the metal. This can be seen in a darkened room.

SUMMARY

Our review should impress us with the fact that electricity can be generated by friction and that it can also be "stored."

We find, too, that there are other ways of generating electric charges. Percussion, vibration, cleavage, crystallization, combustion, evaporation, and pressure, will produce electric charges; also will charge bodies. Some crystals, such as tourmaline, may be electrified by heating or cooling. This response is said to be pyro-electric.

Then too, there is the matter of piezo-electricity, so important in the electronic world of today. There are certain crystals,

many of them common enough, that develop electric charges when pressure is applied in a certain direction. Cady found use for this property in the radio field, years ago. Piezo-electric crystals are not only used in controlling the wavelength of broadcasting stations today, but they are also used in certain electronic mechanisms for the measurement of pressure, and as the sensitive element in microphones, and in pick-ups for electronic phonographs. Such crystals are usually generated by "seed" crystals of Rochelle salts. Quartz also possesses this curious property, and is today widely used in electronic science. (See Fig. 6.)

When these or other crystals capable of demonstrating the property, are ground to a definite size, they respond best to definite frequencies. We shall learn more about them in a later installment of the series.

The observant student will probably have noticed that our discussion, so far, has been concerned with materials like glass, silk, and resins, that do not themselves conduct electricity in the sense that metals conduct. In-

deed, that which we call static electricity (electricity at rest) is always so associated with non-conductors, or dielectrics or insulators, as they are called by the engineers.

Roughly, we have three classes of materials: the dielectrics, the partial conductors and the good conductors. The first list includes such things as oils, glass, porcelain, wool, silk, shellac, rubber, paraffin, etc. The second includes wood, marble, paper, flesh, water, charcoal, earth, etc. In the third we find silver and copper at the top, and the other metals following in proper order.

What has been said may sound as though it had very little connection with the new science of electronics, but eventually we shall see that the whole science of electricity, from which electronics and radio sprang, is merely a matter of charges, positive and negative.

In the next part, we shall discover His Majesty, the electron, and shall find that electric charges are due either to the presence or absence of these tiny units of all matter.

ELECTRONIC ICE INDICATOR

ANOTHER step in the attainment of superiority over nature, and conquering the dreaded ice formation on airplane wings, is the ice indicator, recently an-

nounced by the Minneapolis-Honeywell Regulator Company.

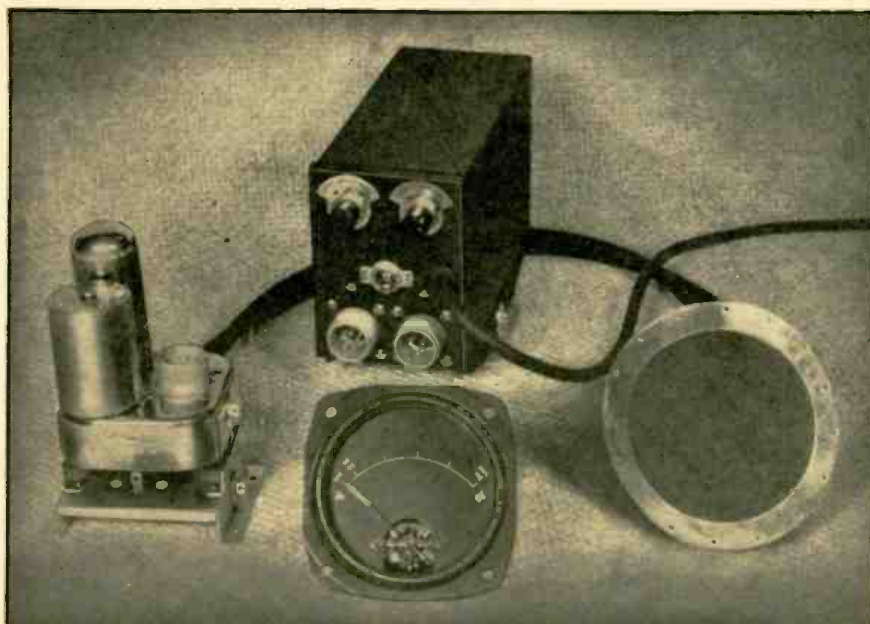

This photo shows the amplifier of the ice indicator at the left, the power supply unit at center back, the indicating meter at center in front and the pickup plate at the right.

With this device the pilot instantly "sees" when ice forms on the wings, and to what thickness.

The invention of a young physicist, this apparatus functions on the basis of two properties of ice considered as the dielectric of a condenser. These two properties are: the capacity, and the power factor.

Investigations showed that these properties change considerably with changes in temperature near the 32 deg. Fahr. level, and compensation is built-in to offset that effect.

The element which "senses" the ice, consists of a perforated metal disc sealed in an insulating plastic mounting plate.

The condenser plate is insulated from the plane and from the ice, and the face of the element is flush with the surface of the leading edge of the wing. The device can start the de-icer system when $\frac{1}{8}$ inch or any other predetermined thickness of ice is deposited on the de-icer boot over the ice-sensing element.

The circuit used is of the balanced type, which makes it insensitive to changes of temperature and humidity.

The amplifier contains only two tubes, thus providing simplicity and freedom from trouble.

All parts hook up with cable connectors, for rapid installation and maintenance.

PROGRESS IN ELECTRONICS AND RADIO

By DR. E. F. W. ALEXANDERSON

PROGRESS marches on a broad front. Among the numerous ideas that are continuously being put forth by research and industry, there are only a few which become known as outstanding inventions, such as Edison's incandescent lamp, and the Wright brothers' first airplane.

But it must be remembered that the desire to produce an electric lamp and an airplane were very much in the minds of many of the scientists of those days. This does not detract from the merit of those who actually were successful. They won the race and proved thereby that they were the best men in their profession at that time. But we can be sure that there were some second-best very close behind.

It often happens that the pressure of the ideas of progress is so great that the same invention is made simultaneously in several places, and there is a margin of only weeks or days to determine who was the first inventor. The greatest single contribution to the use of electric power was the three-phase induction motor. It was invented simultaneously in three countries, by Tesla, Wenstrom and Dobrowolski.

I mention these things because trails of progress in electronics and radio have followed different courses in the past, and seem destined to do so in the future. The immediate opportunities in electronics and radio are well-defined and known by many research workers. They are working toward a common objective but perhaps by different methods. At least this was the situation when the exigencies of war either modified or accelerated normal peace-time research.

If we wish to forecast the industries of tomorrow, then, we may well examine the unfinished developments of today. War is a tremendous stimulant of new discoveries and inventions and we can be sure that after this war there will be a new upsurge in all branches of technology.

The specific lines of research which are in progress now cannot be described at this time, because they are almost all military secrets, but we can illustrate the point by taking some examples of an earlier date from electronic and radio engineering.

Electronics is the latest branch of electrical engineering, but the ideas which are now coming to the fore can be traced as an evolution starting more than thirty years ago.

At that time, broadcasting as we now understand it, was simply an idea. We had an alternator, but not an amplifier, and an amplifier was needed—to build up words and music for transmission, and to build up the feeble signals at the point of reception, so that a listener might easily hear them.

One of the systems suggested was a vacuum tube with a mercury pool and an igniter. The function of the igniter was to control the power flow through the tube by a system of timing the spark. This may seem

The commercial rectifier tubes at that time were built in a characteristic shape resembling a big head with a pair of arms holding up hands on each side. Some investigations by Dr. Irving Langmuir indicated that it was possible to keep the arc burning in the bulbous head and ignite the arc in the side arms by a change in surrounding potential. Perhaps the idea of controlling the power flow by timing the igniter could thus be realized. It was certainly worth trying. So we wrapped the side arms of an old rectifier tube with ordinary tinfoil between the elbow and the wrist. For all the world, it looked like a Rube Goldberg device! Then we applied an alternating voltage, high enough to penetrate the glass. At the same time, a voltage of the same frequency was applied to the electrodes in the ends of the side arms. The experiment was very simple and it worked perfectly. By changing the time phase of the voltage applied to the tinfoil, we had a perfect control of the power flow. The principles had been established, and all we had to do to get a practical device was to have a glass blower insert a graphite block on the end of a wire at the bend of the elbow, to take the place of the tinfoil. This eliminated the necessity of applying a voltage high enough to penetrate the glass.

We had thus a device whereby we were able not only to control the power flow in a rectifier, but also to invert its functioning so as to change direct current into alternating current, whereas its original use was to change alternating current to direct current.

The inverter was thus born twenty years ago, but it is even now not much known because its usefulness in a large scale is still in its infancy. As a preview of the future, we are, however, operating a direct-current power transmission from a 40-cycle water power plant on the Hudson River, and delivering power at 60 cycles in a power house in Schenectady.

Whether our hopes of the future for the system will be fulfilled is still uncertain. We may foresee power transmission of 500 to 1000 miles. There is, however, another opinion in competent quarters, that it does not pay to transmit power more than 300 miles, because it is cheaper to build steam power stations and transport coal by railroad. It is not the place of us who do the developmental engineering to try to settle these questions beforehand. We are concerned in establishing the physical facts and are willing to let economic questions answer themselves.

To complete the cycle of evolution, we may point out that we have now reverted to the ideas of 30 years ago, of starting
(Continued on page 378)



Dr. E. F. W. Alexanderson, G.E. Consulting Engineer, in his laboratory, shown with test set for Thyratron power circuits. Three small metal Thyratron tubes shown on panels immediately in front of him.

technical, but we are all familiar with the spark timer on an automobile engine, and you still use the timing lever to control the power of an outboard motor.

This trail of thought was not followed up for a while because, in the meantime, we became acquainted with the DeForest Audion tube, which was a much better amplifier for radio, and our efforts were concentrated on the development of radio tubes. Ten years later, however, when radio was going strong, our thoughts returned to the starting point. A vacuum tube was then manufactured containing mercury which could carry high currents. Such tubes were used to change—or, as we say, rectify—alternating current into direct current, but their application was limited because there was no way of controlling them. The normal control used in radio tubes, you see, did not work in the presence of mercury vapor. We therefore returned to the idea of the igniter with a timing control. If it could be adapted to the mercury arc rectifier, we would have a device of greatly increased usefulness.

PHOTO-ELECTROGRAPHY— TOMORROW'S MIRACLE

By RAYMOND FRANCIS YATES

For radio experimenters, photography and chemistry fans, this up-to-date discussion of the new means of photography, through the use of electrons, permitting photographs to be taken in the dark as well as in the light, should be unusually interesting. For those with inventive turn of mind this idea may even suggest something for which they have been looking, or will fill the bill for something on which they are working.

TOMORROW you may take a picture—any picture—either in total darkness or in bright sunlight, at a speed of a millionth of a second, minus a negative and without chemical development. You will merely press the button and out will pop the finished article in positive form. No more chemicals, no more dark rooms, no more waiting for negatives and prints to dry. Even today, pictures are being taken at high speed without light of any kind, visible or invisible.

HALLWACHS' WORK

The story of this amazing new trend in the photographic art goes back a long time. W. Hallwachs, a German scientist, was working in a dingy little laboratory outside of Berlin. Here he noticed that a polished sheet of the metal zinc, when charged electrically, would quickly lose its charge when illuminated by light from an arc. That was back in 1888.

Although Hallwachs did not know it at the time, the light was releasing electrons from the surface of the metal. Out of this work came our marvelous photo-electric cells or "electric eyes" and out of it came also the new science of electron optics, based on the discovery that electrons can be made to behave like light.

PHOTOMICROGRAPHY

By the proper arrangement of electrostatic and electromagnetic fields (magnetostatic fields they are called), electrons can be focused, refracted, etc. In the new electric photomicrographic camera developed by RCA, electrons from a hot filament are marshalled into beams that pass through the specimen under examination. During such passage, some of the tiny high-speed particles are slowed down considerably; others barely so. This depends upon the density of that particular part of the specimen through which they are passed.

After having passed through the specimen, the electrons strike a chemical surface that has the power to fluoresce under their impact. The degree of this fluorescence depends upon the speed of the electrons striking it. Thus is a purely electric image of the specimen created on the fluorescent surface. The new and now rapidly expanding art of cathodo-luminescence does not loom up in the uncertain mists of the future. It is actually being practiced today in its early basic forms.

WILCKE'S EXPERIMENT

A few years ago, the first experimentation with electric photography was made by K. Wilcke, in Germany. He photographed rudimentary scenes with what might be called a photo-electrolytic system.

Reference to Fig. 1 will clearly reveal his rather simple mechanism. No film in the

ordinary sense of the term was used, although a conventional lens was employed. In place of the image being formed on a sensitized film, it was cast upon a glass

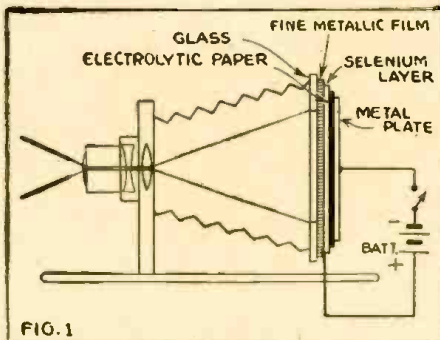

FIG. 1
Sectional diagrammatic view of the camera which uses electrons to "get" the picture, and thus do away with "developing." The picture is ready just as soon as it is taken. Note the similarity of the components of the focal plane to the selenium photoelectric cell, but still a battery is required, which makes for some difference. Undoubtedly this device is the vanguard of similar developments which will take place in the next few years.

plate upon which a super-fine film of platinum had been deposited by special means. So fine was this film that it did not in the least interfere with the passage of light.

Backed up against this metallic film was a very thin layer of the light-sensitive element selenium. Behind this was placed a paper soaked in a solution of potassium iodide; a chemical that will change in color to a deep rich sepia, when electric current passes through it. The degree of color depends upon the strength of the current.

Due to the process of electrolysis being controlled by the selenium, the image cast upon the selenium-covered surface was transferred to the electrolytic paper. Thus one had merely to expose a piece of paper, remove it from the camera, and permit it to dry.

Wilcke also worked upon a special electrolytic negative from which other prints could be made.

CARLSON'S PROCESS

The latest threat to the established forms of photography comes from an American, Mr. Chester F. Carlson of Jackson Heights, N. Y. Carlson uses photo-emissive material; that is, surfaces that will release electrons when they are excited by radiation, in the form of either visible or invisible light. Thus when a scene is focused on such a surface, an *electric charge pattern* corresponding to the scene (called an *electrostatic latent image*) is produced. Naturally, this electrostatic charge pattern is invisible. To render it immediately visible, Carlson in his marvelous camera, deposits a super-

fine powder over it and the powder instantly arranges itself in conformity with the charge pattern. Either the powder is fluxed by heat or sprayed with special material to permanently "fix" it.

In Carlson's electric camera, the light passes through a conventional shutter and lens, then falls upon a photo-emissive surface. This surface is made up of a thin deposit of one of the metals like caesium, sodium, and potassium.

Mounted back of the photo-emissive surface and separated from it by a small air space, is a special sheet material of high insulating value, such as dehydrated cellophane, or cellophane impregnated with polystyrene.

Back of this material, and again separated with a small air space, is a metal electrode connected directly to a battery of 1000 volts or more. Thus the cellophane material is normally in a highly charged atmosphere but the charge "born" on its surface will not be uniform once an image has been impressed upon it. It will vary according to the degree of light comprising the image.

Immediately after being so exposed, the cellophane material is moved along to a second chamber in the camera where the pattern-charged surface is dusted with a superfine powder. This develops the image and its fixation becomes a matter of mechanics rather than of chemistry.

THE SHAFT PROCESS

A number of other inventors are helping to speed the day of non-chemical photography. Lester W. Shaft, of Buffalo, N. Y., has developed a secret process and camera for electric photography. Shaft claims to have developed a special electrically-sensitive ink that changes its color when electric current passes through it.

The degree of color-change will depend entirely upon the amount of current passing, and this in turn, Shaft claims, is controlled by a special photo-emissive surface.

Development of the image is purely electrical, and takes place within the camera itself. No chemicals save those in the ink are used. Once an image is formed and "developed" electrically, by passing current through the ink-coated paper, the ink is merely dried. The drying can be accelerated by properly applied heat.

AVAILABILITY

Although photo-electric photography is not yet ready for the public at large, the field is being developed rapidly, and no doubt many interesting things will happen in the years to come.

Perhaps the camera of the future will develop and fix its pictures as fast as they are taken. The operator will click his shutter and a few seconds later the finished print will pop out.

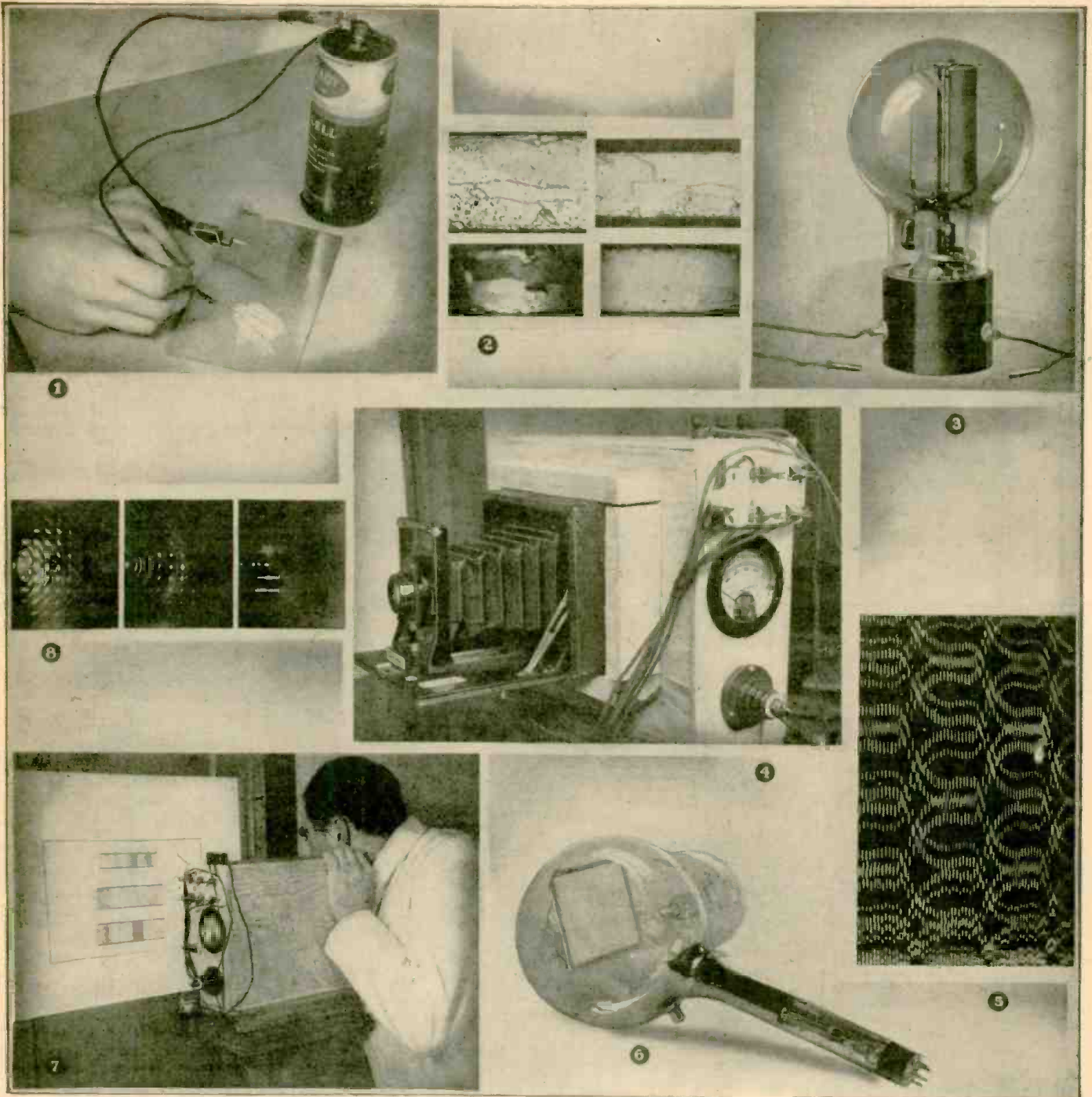

1. The secret of future photography may rest in the properties of this ink, which is able to change its color instantly, upon the passage of small amounts of electric current. The shade is controlled by the amount of current passing. Heavy currents cause the deep grays and blacks, while small currents produce light grays. 2. Patterns obtained when electrons are permitted to pass through crystals and strike ordinary film. 3. The photo-electric cell. It showed the way to lightless photography. The sensitive metal surfaces of such cells emit or discharge electrons when struck with light. The number of electrons emitted depends entirely upon the intensity of the light. 4. A close-up view of the Shaft photo-electric camera. The image to be photographed is caught and focused in the conventional manner. In its present state of development, 2000-volts of direct current is needed to operate the device. 5. No light was used to take this picture. A pure stream of electrons in an oscilloscope produced the pattern. This was one of the first examples of electron photography. 6. The Iconoscope, the major element in television pick-up, is a light-electron device that has inspired inventors to solve the problems of lightless photography without the use of negatives or of chemicals. 7. The Shaft photo-emissive camera, which uses special and secret electrically-sensitive ink, over paper. The ink changes its color to various degrees depending upon the amount of current passing. The current passing is controlled by the number of electrons released from a photo-emissive surface, depending upon the action in the scene to be photographed. 8. Photo-micrographs without light! Here we see pictures taken by means of electrons "boiled" out of heated surfaces of metals. Here too, is a new form of lightless photography that will probably tell us much about the structure of matter.

ELECTRONICS IS CATCHING ON!

LIKE a popular song catching the public fancy, or a sure-fire slogan that is heard on all lips, the word *ELECTRONICS* seems to be heard on all sides these days,—in the daily press, in schools, in Wall Street, in factories, in trade and technical literature.

What brought it about? Well it's probably any man's guess, but our conjecture is that it went something like this:

Prior to Pearl Harbor it was a more or less restricted term, used by radio engineers to designate certain types of tubes or certain kinds of equipment used for purposes surpassing human ability. Physicists regarded it as that branch of physical science pertaining to the electron, its action, its mass, its velocity, and its manifestations.

Electrical engineers knew of it as some-

thing pertaining to the theory of vacuum tubes.

Then the cataclysm of war descended upon us and our industrial might was jabbed into a furor of activity that the world has never seen.

Tied in with this sudden industrial activity was the tooling up for war. New machines, better machines, better product

(Continued on page 381)

ELECTRONIC TUBES FOR SERVICEMEN

By IRA KAMEN

SINCE Lee De Forest first put the famous "Edison Effect" to work in the electronic vacuum tube that made radio possible, many similar tubes have been developed in the nation's engineering laboratories. There are many electronic tubes which can do jobs that have to be done in a hurry—and in most cases do them better.

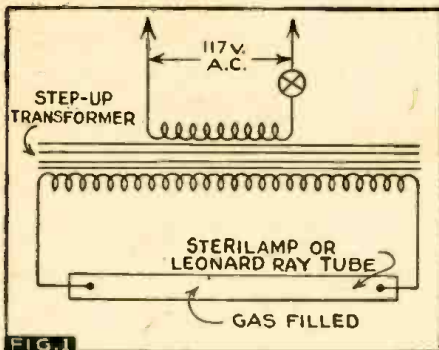

FIG. 1 Basic circuit of the Sterilamp, the widely used bactericide.

Many of them are well known, but with few exceptions these tubes have been ignored by the men whose job it should be to install them.

Possibly some radio men have been frightened away by such names as *Sterilamp*, *Thyratron*, *Grid-Glow*, *Supervisory Protector*, *Ignitron*, *Leonard Ray* and *Phanatron*. Perhaps others felt that circuits involving these vacuum tubes require an engineer for installation. Heretofore this lassitude was merely unsound business practice; today it's wasteful neglect of developments vital to the unified war effort.

It takes no engineering skill to install these tubes. Any man with a radio background and a knowledge of the *fundamentals of electronics* can do the job quickly and simply.

Briefly this is a summary of the most widely adaptable of the electronic tubes; what they have done, what they can do, and how they can be of most value.

THE STERILAMP

This baby is the snappiest little microbe killer of them all. This tube has just begun

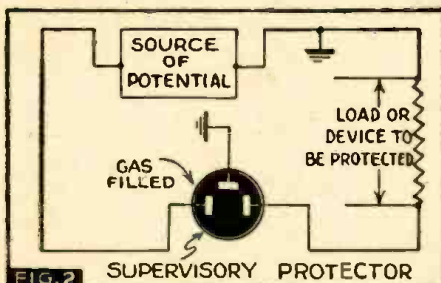

FIG. 2 Hook-up of a supervisory protector.

to emerge from obscurity, and has a thousand-and-one uses. This tube radiates ultra-violet rays which mean instant death to bacteria, fungi, and mold.

Sterilamp has licked the spoilage problem for the meat industry. Previously the only way to store meat for any period and keep it germ-free was sharp freezing and chilling.

But this process robbed the meat of its juices and vitamins, shrunk it, and discolored it. Recently several of the more progressive storage houses have installed Sterilamp. They have found this electronic tube an economical and highly efficient answer to the key problem of storage as the meat moves along the line from slaughterhouse to the modern streamlined meat counter. Sterilamp, operating at normal temperature of about 70 degrees Fahrenheit, does the job of high-cost extreme refrigeration, without shrinkage, or discoloration, or waste of important food value. This means better, richer, meat for the consumer and less complaints for the butcher.

Other uses of the Sterilamp are manifold. Think of any situation where antiseptic cleanliness is imperative to human health and ten chances to one you can use Sterilamp. For example, the commercial baker has to deliver his bread, cake and rolls to the consumer's table fresh and mold-free. Mold spores, which are always present in the air, attack these important foods as soon as they come out of the oven. A Sterilamp would kill these molds even if they get on these foods.

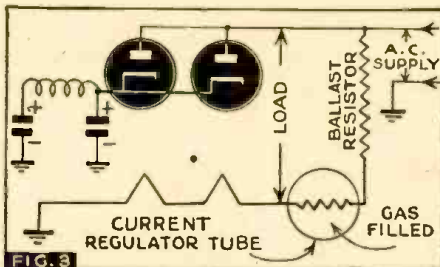

FIG. 3 Current regulator tube stabilizes heater potential when A.C. supply fluctuates.

Similarly this ultra-violet-ray emitter could be used in restaurants, soda fountains and hotels to protect drinking glasses and silverware.

Every barber shop, every beauty parlor, could use a Sterilamp hook-up to replace complicated and ineffective steam methods of sanitizing the much-used instruments.

Sterilamp's life-saving potentialities make it A1 material for active military service. Install it in barely equipped combat hospitals, and slice the startling mortality from infection of the last war, to a minimum.

On the farm, Sterilamp has countless possible uses. The sanitation of the storage and delivery of milk and milk products would protect the most vital source of the nation's food supply. Beneficial installations could also be made in poultry houses and incubators, to protect the extremely susceptible hens and chicks. One company has even put Sterilamp on duty guarding the humble but so important toilet seat. The limits of the use of Sterilamp are only those of the radio-man's ingenuity. Economical to operate, easy to connect to an A.C. transformer as shown in Fig. 1, and possessing an exceptionally long life (4000 hours under normal operating conditions), Sterilamp has endless practical applications.

THE LEONARD RAY TUBE

This is a small-scale death-ray that forecasts a diseaseless future for mankind. The

tube is constructed with a special glass window which allows the passage of high-speed electrons.

The electrons are concentrated into beams which are so powerful that they not only destroy microscopic bacteria, as with the Sterilamp, but also insects as well. Roaches,

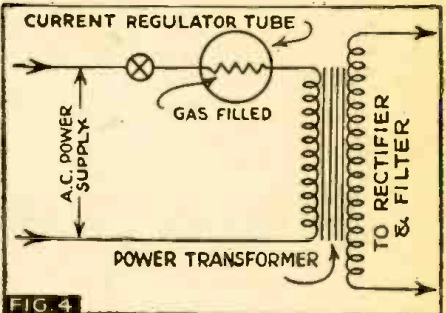

FIG. 4 Current regulator used to stabilize power supply input voltage.

fruit flies, locusts and house-flies can be electrocuted instantly when they pass through the beams from this tube. The radio-man can commercialize the Leonard Ray with installations in hot-houses, food-markets and other places where disease-carrying insects are likely to do considerable damage.

Leonard-Ray tube installation and operation is as simple and economical as with the Sterilamp.

THE SUPERVISORY PROTECTOR TUBE

Here is the ideal inexpensive replacement for costly cumbersome relay systems used in many control applications. Constructed with three graphite electrodes enclosed in a gaseous atmosphere, the supervisory protector can handle virtually any control job where surges of voltage occur. Two of the electrodes are connected with the circuit to be protected, while the third is grounded as shown in Fig. 2.

Sudden voltage rise causes the third electrode to become conductive and drain off the excess to the ground. One drawback of this tube is that extremely high voltage will destroy it. However, even when the tube is ruined the flow to the ground is maintained

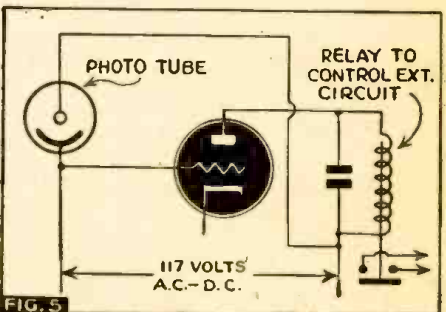

FIG. 5 Phototube controls a relay circuit.

and the circuit saved regardless of the voltage quantity.

A Supervisory protector system is believed by many engineers to be more
(Continued on page 377)

RADIO AND TELEVISION AFTER THE WAR

By H. S. KAHN

SOON after the war America will launch into a new era in radio. New F.M. and television broadcasting stations will spring up from coast to coast; millions of people will be flocking to buy new radio and television receiving sets. Two-way radios will find a new civilian market; television schools and theatres will enter the thriving scene; the amusement and advertising worlds will be revolutionized, and new fortunes are going to be made by enterprising men, many of whom are at this moment obscure figures in the business world.

How will these new fortunes be made?

WIDE OPEN TOMORROW

Let's review the specific possibilities:

Would you like to own a radio broadcasting station? It's nearly impossible to break into that field today; the lucrative locations are all taken. But it will be wide open tomorrow. An ordinary station cannot broadcast F.M. or television. A recent FCC ruling prevents one company from owning or operating or managing, directly or indirectly, more than three television stations, thus throwing open hundreds of opportunities for all comers. The demand for television on the part of the public and advertisers is certain to be enormous. It will be one of the richest fields in the world.

The transcription business, one of the highly lucrative branches of ordinary radio, will take a new form in television. Phonograph-type recordings will be replaced by filmed recordings of television broadcasts, which can be profitably syndicated to small television stations throughout the nation. The much higher cost of television programs will insure a constant, heavy demand for these film-transcriptions.

RCA has already developed a television projection receiver for theatre use that casts

images 15 feet high and 20 feet wide on a movie screen. Satisfactory television receiving sets for home use are likely to remain costly for some time to come. A special theatre, offering television programs, will be able to make a "killing" in every large community while television is in its first flush of exciting novelty.

Eventually, when technical obstacles to piping television broadcasts over vast distances have been overcome, as they are certain to be, an entrepreneur in every major city can offer telecast Broadway stage shows to the public in a special theatre at movie prices. This system will make it possible for a New York company to appear simultaneously in as many as 200 cities in a single week "on the road," without leaving Broadway.

One of the greatest money-makers in the history of the coin machine industry was promised by the advent of the coin-in-the-slot automatic movie machine. However, success in this field has been handicapped by mechanical difficulties; the machines are complicated, frequently break down. Similar machines, using television instead of movies, will be highly successful during the early years of television. There are no moving parts to break, and until television becomes commonplace the public will find them irresistible. There are thousands of locations.

TELEVISION SCHOOLS

Television broadcasting requires a completely new technique. Profitable schools will be established both for television engineers and performers. Post-war job seekers will flock to them, for the career opportunities will be plentiful, salaries ample.

All sorts of varying equipment will be needed for television programs—scenery,

make-up, new and improved types of lighting, stage properties and other essential items, the manufacture of which will represent another specialized money-making opportunity.

The enormous public interest in television will give rise to exclusive television retail stores in every large city. Needless to say, they will be crowded with customers from the moment they open their doors. For best results, time the opening of the store with the first broadcast of the new local station.

Television will afford numerous opportunities in the manufacturing of receiving sets and replacement parts. A constant flow of new inventions will make possible a constant change and improvement in sets, and the independent manufacturer who acquires the patent rights to such new inventions will be able to produce a highly salable product. Finding and securing such new inventions will be the primary basis of television manufacturing opportunities for a long time to come.

The Hollywood agent—the "ten percent"—is in business on a huge scale. Television, with its inevitable emphasis on stars, will open up new opportunities in the agency field.

Publishers will be interested in a new field of opportunity that will be opened up by television. The large number of successful movie fan magazines owe their big circulations to the public's interest in visible movie stars (as opposed to invisible radio stars). Television will create hundreds of new stars in this separate field and the television audience, which will inevitably exceed the movie audience, will be a prime market for television fan magazines. (Book publishers should anticipate now a huge demand for

(Continued on page 378)

RADIO FREQUENCY VOLTMETER

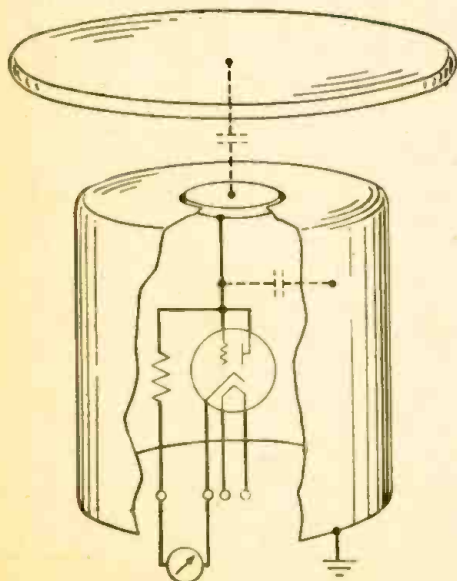

View showing tube acting as the large capacitance.

MEASUREMENT of the high voltages encountered in radio circuits requires a potential divider because measuring instruments cannot take the full differences of potential.

One method is to connect a large and a small capacitance in series across the voltage and measure the drop across the larger capacitance. This drop can be made small by using a large ratio of capacitances, since the voltages of two condensers in series divided inversely as their capacitances.

In the radio-frequency voltmeter shown here the top plate, which is about 3 inches in diameter, and the small metal disc concentric below it, form one capacitance. Distributed capacitance between this disc and the ground provide a much larger series capacitance whose potential can be conveniently measured.

A vacuum tube rectifies the potential and a milliammeter in the tube circuit indicates the full voltage.

With this arrangement voltages up to 10,000 volts with frequencies up to 50 megacycles can be measured.—Bell Telephone Laboratories.

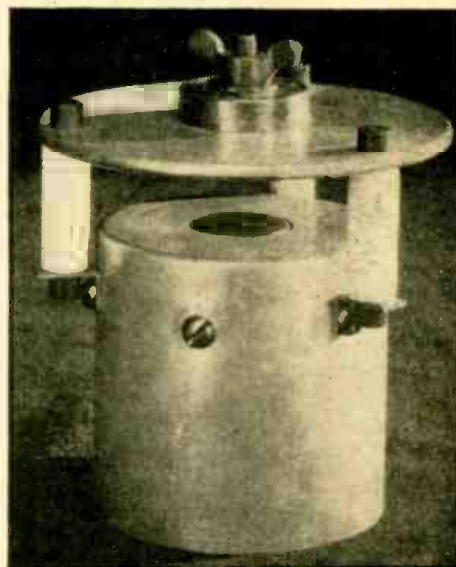

Appearance of the high-voltage meter. The capacitance between the top plate and the disc mounted in the can constitutes one capacitor, the smaller one.

SUBMARINE DETECTION

By FLOYD B. NEYHART

Presenting both old and new methods of submarine detection and signaling devices

ALTHOUGH practically every other branch of science has had considerable technical application, that of acoustics has, until the last few years, remained practically in the academic stage, and few even among scientific men gave serious attention to it. Bells, gongs, whistles, sirens, and musical instruments have been used from remote times both for enjoyment and for signaling purposes, but their development has mainly been on empirical lines, with little assistance from the physicist.

The war has, however, brought about a striking change in this in many directions, and acoustics is now becoming an important branch of technology. Acoustic signalling is of especial importance in connection with navigation, as sound is the only form of energy which can be transmitted through water without great loss by absorption.

Since in sound phenomena it is well known that the motion of each particle of the medium is mainly forward and backward along the line of propagation, sound vibrations are therefore spoken of as longitudinal vibrations. It follows from this that there can be nothing in acoustics corresponding to polarization in light.

In this paper we are concerned chiefly with the velocities in air and in sea water, although the acoustic properties of other substances require consideration when the transmitting and receiving devices are being dealt with.

In air at temperature t degrees the velocity v equals 1087 plus $13.8 t$ minus $0.12 t$ squared feet per second. For sea water having a salinity of 35 parts per thousand, the velocity is as stated above. For each additional part per thousand increase in salinity there is an increase in velocity of about 3.7 feet per second. This gives a velocity of 1123 feet per second in air, and 4984 feet per second in normal sea water at a temperature of 20 degrees C., so that the velocity in the sea is about four and a half times as great as in air.

When sound passes from one medium into another, it can be shown that unless the two media have the same acoustic resistance there will be a certain amount of reflection at the interface. The ratio of the acoustic resistance of the second medium to that in the first is symbolized by "r." The ratio of the energy in the transmitted wave to that of the original wave is the efficiency of transmission which is

$$\frac{4r}{(r + 1)^2}$$

For water and air transmission the efficiency is only a little over 0.1 per cent. This presents great difficulties in all underwater listening, as the sound passing through the water must generally pass into the air before falling on the drum of the ear.

Since for sound to pass from water through the side of a ship to the air inside, the efficiency would be only about 0.00052 per cent, the practice of mounting inboard listening devices, either directly on the sides of the ship or in tanks of waters in contact with the hull has become almost universally practiced.

Acoustic receivers may be classed as pressure receivers, analogous to electrical

voltmeters, and displacement receivers, analogous to ammeters. The distinction between pressure and displacement receivers is that in a pressure receiver the diaphragm is comparatively rigid and yields very little to the vibrations, while in a displacement receiver the diaphragm is very yielding. This distinction is particularly important in the application of directional receivers. The displacement receiver will give a maximum intensity when facing the source, while the pressure receiver is unaffected by directions.

The simplest form of an underwater receiver is analogous to the simple trumpet for air reception and is called the Broca tube, which consists of a length of metal tube with a diaphragm over its lower end. When this is dipped into the water, the sound from the water is communicated through the diaphragm to the air inside the tube, and the observer listens at the free end. This is moderately effective, but not sensitive or convenient, as it makes no provision for amplifying the sound. Modern hydrophones are therefore nearly all of an electrical character, containing microphones or magnetophones from which electrical connections are taken to ordinary telephone receivers at the listening point. Two types of microphones are used (1) solid back type and (2) the button type. Both types correspond approximately to pressure or displacement receivers.

The problem of directional transmission and reception is among the most important as regards acoustic transmission. Since the sound waves tend to radiate more or less uniformly in all directions with the result that their intensity rapidly diminishes according to the inverse square law, there is great difficulty as regards interference and want of secrecy. Also there is little value in a receiver which will detect the existence of a sound but gives no indication as to its direction.

There have been several successful devices for directional listening. Among these is the "Binaural Method of Directional Listening." This device consists of two ear trumpets which are fixed to a horizontal

bar, each of which is provided with a definite length of rubber tubing to an air piece. When a sound is heard, the observer swings the bar carrying the trumpets around in the direction indicated and as he does so the sound appears to cross over from one ear to the other. This occurs at the binaural balance and the bar is at right angles to the source. This same principle can be applied to under water listening with considerable success.

For the case of electrical receivers the binaural method may be replaced by what is called the sum-and-difference method. This method replaces the ear trumpets with microphones which are connected to two telephone transformers, the secondaries of which can be connected in series as shown in Fig. 1.

It is evident that if the source is in the median plane, so that the sound reaches both receivers simultaneously, they should be similarly affected and produce equal electromotive forces in the transformer secondaries. In case the source moves to one or other side of the median plane, the sound will reach the two receivers at different times, and cancellation should no longer take place, so that the source should appear louder the greater the angle of reception from the median plane. By swinging the bar until the sound vanishes, or at least becomes a minimum, the direction of the source is given.

The actual devices employed for submarine signalling may be described under the headings (a) transmitters, (b) receivers, and (c) directional devices.

The simplest form of submarine transmitter is the submarine bell. The bell made of bronze, weighing 220 lbs. and having a frequency of 1215 cycles per second in water, is struck by a hammer generally operated by compressed air.

On account of the ease of operation and control, electromagnetic transmitters have been most popular, and they are now made up to large sizes transmitting hundreds of watts of acoustic power. They may be divided into two classes: (a) continuous, and (b) intermittent or impulse transmitters, corresponding to the continuous wave and the spark methods of wireless telegraphy.

The continuous type transmitters, as developed by the Germans, have a mechanical efficiency of about fifty per cent. A great objection to these moving iron transmitters is their inherently low power factor owing to their great inductance, which involves a large wattless, exciting current.

The Fessenden transmitter is probably the most efficient and powerful of all electromagnetic transmitters. This transmitter employs a fixed coil which induces currents in a copper cylinder by transformer action; the copper cylinder is attached to the diaphragm. The arrangement is very rigid mechanically and a high power factor and efficiency are obtained at resonance, which is usually for a frequency of 1050 cycles per second. Transmitters of this type are capable of signalling under water to a distance of 300 miles or more.

The bell was the first type of intermittent submarine transmitter which could be op-

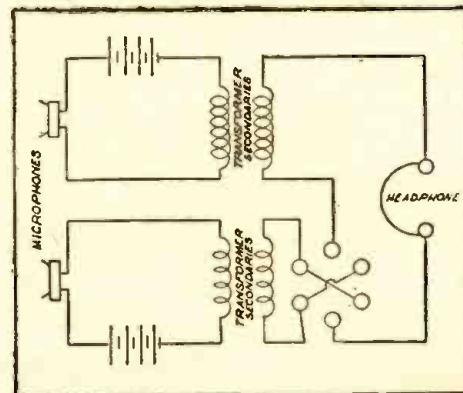

The wiring diagram for the sum-and-difference method of listening is simple and the mechanism is easily operated.

(Continued on page 377)

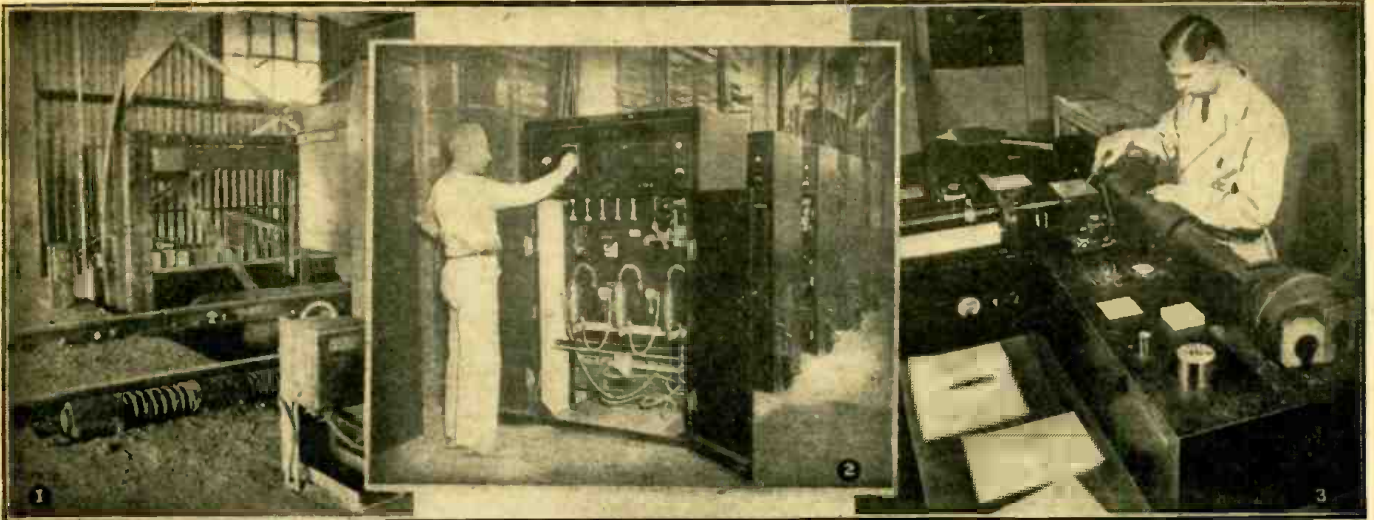

1. Shows a phototube relay apparatus installed at the unloading platform of a coal preparation plant. This set-up prevents a car from being dumped after having been unloaded, thus permitting only one car at a time to be in the cradle. 2. Control cabinets housing thyratrons, phantons and associated equipment used to control automatic welding machines. 3. Shows Dr. Walter Granville adjusting the recording spectrophotometer in the laboratories of the Interchemical Corporation. The spectrophotometer is recognized by the American Standards Association as the basic instrument for the fundamental standardization of color.

ELECTRONICS—Its Latest Miracles

By S. R. WINTERS

LIKE a tourist traveling through a picturesque region in which scenic vistas unfold with such rapid succession that only the highlights are "landscaped" on our memories, the science of electronics is so thickly studded with new developments that they seem to maneuver "squeeze plays" for recognition.

As variable as they are numerous in their applications—and these are too many to be computed and too elastic to be defined—tiny electrons have well-appointed tasks as widely different as smoothing the surface of war-precious tin and counting money for the blind. Electronically speaking, other novel uses include: Detecting the depth of infiltrated sea water in the closed compartments of ships; sluicing bodies into vacuum chambers; matching the lipstick, nail-polish and powder of milady; guarding against accidents at coal plants; detecting moisture in the manufacture of precision parts for guns, planes, and tanks; distinguishing between 2,000,000 shades of color; spot-welding in aircraft factories; "memorizing" and "forgetting" the disturbances and patterns of a television station; and recording the varying temperatures at 144 different points on an airplane.

COUNTING MONEY FOR THE BLIND

By employing the well-known principle of the "electric eye" and its complement, a beam of light, persons bereft of sight may evaluate different denominations of money. A beam of light, in a portable machine, recently demonstrated at the American Foundation for the Blind, New York City, scans the numerals on United States paper currency. The number of times this ray of light is reflected from the bill of money is indicated by a buzzing sound. The number of audible sounds then tells the denomination of the bill. For example, four buzzes indicate a \$20 bill, three a \$10 note, two a \$5, and one buzzing noise indicates a dollar bill. Just as some forms of animal life are reputed to be severely limited in the numbers they can count, this weird device can

detect bills only up to \$20. George A. Lafleur of Overbrook, Ontario, is the inventor of this apparatus.

ELECTRONICS DETECT SEA-WATER DEPTH

The depth of sea-water seeping into closed compartments of ships of the United States Navy and Merchant Marine may now be determined electronically. By virtue of an invention of Glen W. Neely, of River Forest, Illinois, it is claimed that tests in laboratory and on ships have demonstrated that this electrical device, when mounted as prescribed, will not be short-circuited by sea-water films, and, moreover, will cut the oil on the surface of a rising body of sea water. This wards off any appreciable coating of oil scum or film on the exposed wings of the device.

A silver or cadmium electrode is located near the bottom of the ship's compartment—when infiltration of sea water is suspected—and a series of electrodes of another metal, such as silver, is placed at various levels. The bottom electrode serves as one side of an electric circuit and the other electrode, as the other side of a series of currents. Then it is feasible to register the currents thus generated on conventional recording instruments, and thus detect the presence of sea water and determine its depth in the ship's compartment.

SLUICING BODIES INTO VACUUM CHAMBERS

For special use in electronic microscopes, a device for sluicing bodies into vacuum chambers has been designed by Heine Otto Muller of Berlin-Pankow, Germany. It may seem to the casual reader that this is a sort of will-o'-the-wisp affair—you see it and you don't see it—for the inventor tells us that "it is possible to displace the object in the vacuum chamber and to bring it within a very short distance of the objective." Seriously, in describing this device, it is related that the object is held in a cartridge which may be displaced within the applica-

tion plug. The object is thrust partly out of the plug into a certain position against the exertion of a spring which tends normally to hold it within the plug. The cartridge may be thrust out of the bore of the plug toward the objective in the operating position of the plug by a rack-and-pinion arrangement. It may be held in a desired position by stops. The cartridge consists of a cylindrical tube, closed at the end facing the objective, by the object-holder proper.

The thing to be examined—say, a thin layer previous to cathode rays—is so attached to certain parts that it covers the central opening of these parts. The cathode ray, once having penetrated the thin layer or object, enters the central opening of the optical lens and thereby is subjected to an electron-optical bias. This procedure insures a magnified image of the object.

ELECTRONIC "OSCAR" IS A COLOR MATCHMAKER

Perhaps taking its name from "Oscar," the celebrated dummy employed by the Federal Bureau of Investigation in its studies of criminology, an electronic machine used in matching cosmetics and women's clothes, has also been dubbed "Oscar." Dr. Walter Granville, color technologist of the Interchemical Corporation of New York City, ventures the opinion that the photoelectric spectrophotometer will enable women to match their shoes with their suits—and they'll stay matched under varied lighting conditions. Prophetic of the future, this technologist ventures, "You can see how it would help match lipstick and nail-polish—and how it keeps different batches of powder the same shade." House painters, too, eventually may consult certain color curves to determine exact shades of colors for living-room walls, etc.

GUARDING AGAINST ACCIDENTS IN COAL PLANTS

The loading of coal cars at the New Piney Fork preparation plant of the Hanna (Continued on page 376)

INSTRUMENT MEASURES HEARTBEAT OF UNBORN

FOR some years physicians have experimented with apparatus for detecting and measuring heartbeats of the fetus (unborn child), in order to determine its progress, etc.

Considerable work has been done, especially with an instrument called the electrocardiograph (electric heartbeat recorder).

A pre-amplifier is used to build up the tiny pulses so that they will be sufficiently

large to be detected on the electrocardiograph.

This amplifier consists of two No. 19 type tubes or 1G4-G's, battery-operated of course, in a direct-coupled circuit. The second tube, or output tube, has in its plate circuit, a tapped load resistance which permits steps of amplification to be taken off and applied to the electrocardiograph itself for recording.

The exploring electrodes are two metal

discs which are placed upon the abdomen of the patient. From these, leads run to the pre-amplifier, and from there to the electrocardiograph.

The electrocardiograph converts the electrical impulses into the movement of a recording pen on the chart paper. Thus a permanent record is obtained for future verification and analysis.

Interest in clinical fetal electrocardiography started in 1906 when Dr. Cremer published two tracings apparently showing fetal deflections superposed on a maternal electrocardiogram.

Little progress was made until 1930 when two Japanese investigators designed a tube amplifier which, in conjunction with a galvanometer, comprised an instrument of sufficient sensitivity to record the fetal heartbeat.

In 1938 Dr. Bell using similar apparatus was able to obtain deflections much greater than any obtained up to that time.

Until very recently the chief work of clinical importance, as judged by the high incidence of positive results, was that of Dr. Strassmann and his associates. They used the usual galvanometer type electrocardiograph without amplification. More recently Drs. Mann and Bernstein reported even better results with an amplifier type of instrument, with abdominal leads instead of limb leads.

Recently Drs. Goodyer, Geiger and Monroe decided that a more satisfactory record could be obtained if a pre-amplifier were interposed between patient and the electrocardiograph. Such an amplifier was constructed, and is the one described above. The results promptly established the adequacy of the technique. Drs. Bernstein and Mann also, recognized the value of pre-amplification, and in recent tests reported much greater sensitivity; as high as 6 cm. per mv., compared to per 1 cm. per mv. on the standard electrocardiograph.

(This article was prepared from data supplied through the courtesy of Arthur J. Geiger, M. D.)

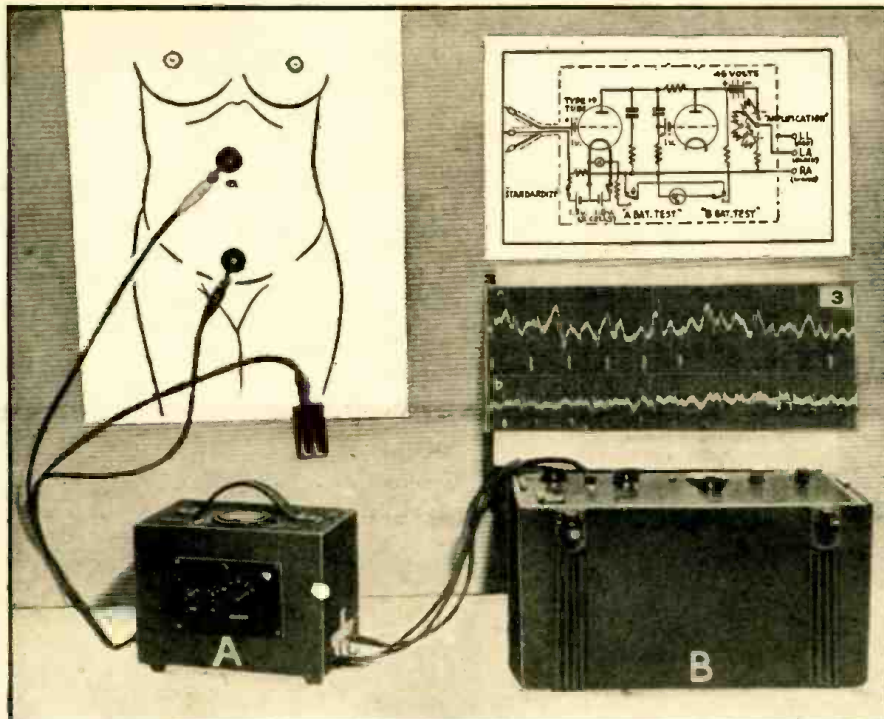

In this photo of the electrocardiograph and associated equipment, the placement of the abdominal leads is shown in the upper left. At the bottom on the left is the battery-operated direct-coupled pre-amplifier. On the right, at the top, is shown the circuit diagram of the pre-amplifier. Just below it is a chart of two comparative cardiograms. The upper one, with the larger amplitude, is that obtained with the apparatus shown. The lower one, with far less amplitude, is that obtained with the standard equipment as used heretofore. At the bottom on the right is shown the electrocardiograph itself, mounted in its portable carrying case.

ELECTRONICS AND INDUSTRY

THAT the electronic way again and again proves to be the best, and often the only, solution to a multitude of industrial problems, was the keynote of an illustrated talk given recently before the Engineering Society of Western Massachusetts at Springfield, Mass., by Warren C. Hutchins, Manager Sales of General Electric's special products section of the Industrial Department.

Great opportunities for many industries—steel; machine tool; textile; printing; paper; agriculture; motion pictures—lie in electronics, Mr. Hutchins declared. The industries that take full advantage of these opportunities, he stated, will be years ahead of those that do not.

Twenty-five years ago the electron tube was but an experiment in the hands of scientists, its unlimited potentialities suspected but not yet proved. Today, electron tubes are performing numberless war tasks in production and combat, and in industrial applications. They measure, count, sort, control the speed of motors, and open and close circuits carrying thousands of am-

peres, more accurately and safely than otherwise possible. Furthermore, they accomplish all this without the use of moving parts.

Electronics in industry, it was said may be classified broadly as including *Measurement, Control, and Power Devices.*

Electronic measurement devices magnify man's power of perception and extend his senses. The various speed, pressure, thickness, and strain gages; the mercury vapor detector; the vibration velocity and amplitude meter; and the spectrophotometer (color analyzer) are representative of this class of electronic devices.

Electronic control devices translate man's will into action, controlling a few thousandths of a watt or thousands of kilowatts. The photoelectric relay, or "electric eye" of popular fiction, and the resistance-welding-control are well known electronic control devices. Electronic control, it was pointed out, makes possible the timing and controlling of the heat used in resistance welding with a speed, precision, and reliability

which is not possible by any other method.

Electronic power devices are those which in themselves handle the heavy electric currents in an especially desired way. While the number of applications of electronic power devices is limited as compared with those of the measurement and control devices, the electronic-type power oscillators, and the various sealed-type and pump-type ignitron rectifiers are typical of the more widely used electronic power devices.

The electron tube, it was explained, is essentially a glass or metal container, into one end of which is sealed an anode (plate) connection, and in the other a cathode connection. The tube may also contain a few drops of mercury or some inert gas. The vapor from the mercury of the gas provides a secondary source of electrons of many times the capacity of the primary source, which is usually a heated filament. If the tube is connected in an electrical circuit, it will pass current when the anode is positive with respect to the cathode and if no grid is present.

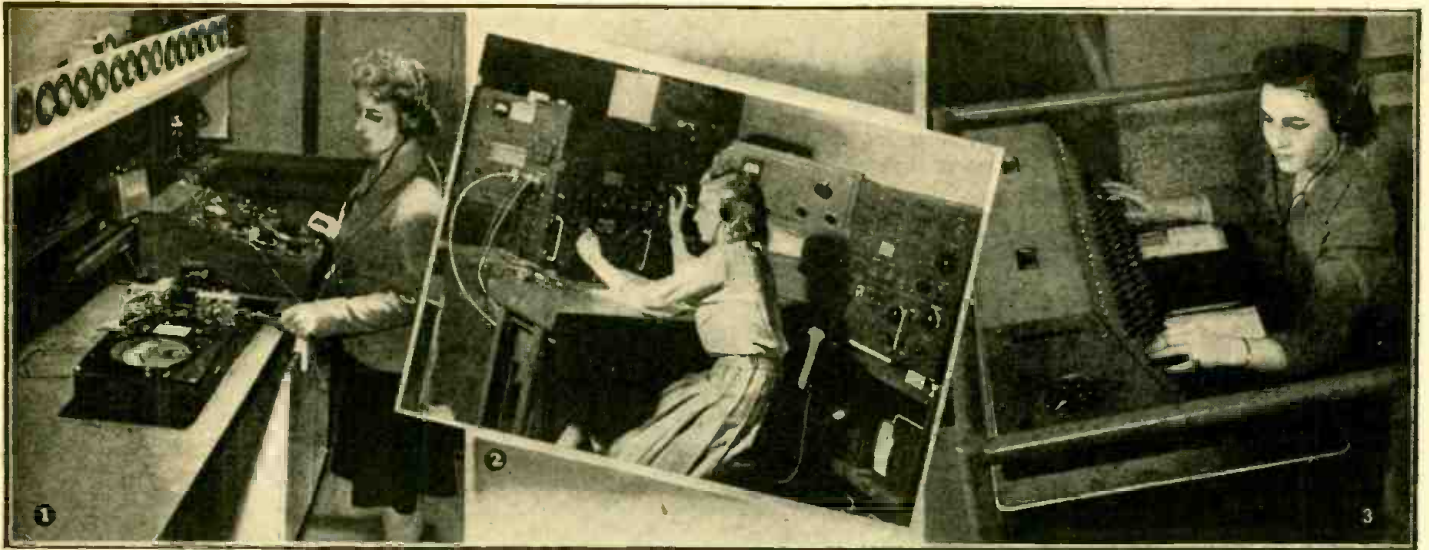

The photo on the left shows Mrs. Doris Ausmus, laboratory technician, who is now doing her bit in the same kind of work she did before she was married and first started with G.E. In the center is shown Miss Joan Beckett, graduate of Mt. Holyoke College, who is employed in the television studio at WRGB. Miss Beckett also writes scripts for telecasts, and helps direct some of the programs. On the right is shown Miss Billie Brooker, graduate of Iowa State, who calibrates radio transmitters in one of the large manufacturing plants.

WOMEN IN RADIO

MORE and more each day we hear of the jobs which women are taking in industry, jobs which formerly were strictly the domain of the male.

Women are proving themselves equal to the demands of wartime industry and are doing a wonderful job. College girls, with majors in math or science are using their knowledge or are fast being retrained to immediate demands of defense work.

We cite herewith a few examples of women active in radio work.

PIONEER RADIO WOMAN RETURNS

Twenty years ago Miss Doris Evans was one of the first women assistants in the original radio department at G.E.'s research laboratory.

She started as a secretary and then was transferred to the research laboratory. She studied mathematics at Union College for four years (one of the first women to study at this men's college). She then became a laboratory assistant, making wiring diagrams for radio equipment; testing ap-

paratus; and keeping data on measurements.

During this time she met and married Delbert Ausmus, now a Colonel in the U.S. Army. Col. Ausmus was at Corregidor and is reported missing, presumably captured by the Japanese.

Mrs. Ausmus, with other Army wives, was evacuated in the summer of 1941 from the Philippines. Now that she has returned to Schenectady her scientific training and experience are helping speed research for the war.

GIRLS TEST RADIOS

Billie Brooker, an Iowa State graduate, is shown calibrating a radio transmitter in one of the plants of G.E.

For years such jobs as this have been done by men, but under the stress of war conditions, the famous training course for graduate engineers is opened to women.

Test girls replace test men on some of the work, and in other cases they will give highly skilled assistance to the engineers

in the laboratories and factories.

Requirements for the course consist of a degree in physics or mathematics. So far some 40 women are enrolled and are being rotated in the various departments doing computation work, plotting graphs, calibrating precision instruments for machine tools, and doing production test work on some of the simpler devices used in various factory departments.

The girls attend classes in both theory and laboratory work, obtaining a good grasp of the fundamentals of engineering. Graduates from colleges all over the country are represented in the enrollment.

ELECTRONICS EXPERT

One of the first women to win a high place in one of the many phases of that new science—electronics—is Miss Joan Beckett, graduate of Mt. Holyoke College, who is employed in the television studio at WRGB. Miss Beckett also writes scripts for the telecasts, and helps to direct some of the programs.

SIGNAL CORPS RESEARCH EQUIPMENT

In the laboratories and testing sheds scattered about Fort Monmouth, the Army is busy continuously, seeing to it that the men in the field get the best and the latest in equipment.

Done here is the type of research that cannot be done by radio manufacturers. For example, at one time a critic of the program wanted to know why standard police radios could not be used in tanks, etc. They took this gentleman for a ride in one of the little steel mammoths. After being jolted and tossed about for a nice quiet 30 minutes, he was able to answer the question himself.

Reports from the fronts on how the equipment is standing up, or how it is falling down, are constantly scanned by the engineering experts, who devise methods and schemes to overcome these drawbacks, and rush the improvement suggestions to the manufacturers so that the latest equipment contains all the new advantages and none of the old disadvantages.

For instance, one development, now dis-

closed by the officials, consisted of doing something about portable transmitters. In the old days they had to be unloaded from a truck (taking up time and manpower), set up on the ground, and hooked up to the power supply, before they could be put into operation. Now all that is necessary to be done consists of operating the transmitter on the truck while it is in motion! It is self-contained, never has to be lifted off, and is ready to operate at all times. A tremendous advance, and a terrific aid in rapid troop movements. And bear in mind the fact that these transmitters embrace the most complicated and intricate manufacturing skills. Other branches of the research staff are consigned to the task of developing equipment for operation in all wave bands, for detecting and locating transmitters used by the enemy. It appears that the number of enemy transmitters that are spotted and located, is an index of the size of the body of their troops.

The direction-finders being used make all

pre-Pearl Harbor models as ancient as the Dodo. Another interesting development is a water-tight floatable radio, sealed to a single frequency, and set to automatically give out its signal. If Captain E. V. Rickenbacker and others had had such a device they might have been located sooner. This will be a god-send to all others in the future who drift about in life-boats. Their location will be spotted that much quicker by scouting planes.

Another radio contemplated is a handy-talkie that parachutists may use to communicate with each other.

Still another piece of apparatus would consist of a combined weather station and a radio transmitter. It can be buried anywhere, usually in locations where observations cannot be taken by us, owing to the presence of the enemy. For two or three months the batteries connected to it will keep it in operation, transmitting in signals, every few hours, data on temperature, barometric pressure and humidity.

ALL-ELECTRIC SIMPLICITY-1

By FRED SHUNAMAN

AN electrified Simplicity-1 was promised in the January article. Experiment showed that the modified Twinplex circuit used with the battery receiver was not well adapted to electrification. Any regenerative set tends to reproduce 60-cycle hum when the regeneration control is advanced to a point near oscillation, and the Simplicity-1 was far from being an exception to the rule.

In our January issue we described the battery operated "SIMPLICITY-1" receiver using the new Gernsback Capind-tuning method. This is the second article. We would like to hear from readers who built the set.
EDITOR.



Tuning-up the all-electric model. The control being adjusted is the antenna tuner; the other one is the R.F. plate unit. Ventilation slots at the bottom of the receiver are easily discerned. Note glass cover on receiver.

Hum and instability led to an attempt to get away from regeneration altogether. The Electric Simplicity-1 therefore uses a different circuit from its battery predecessor.

A non-regenerative set demands radio-frequency amplification. We did not want to abandon the 1-tube idea, so a combination tube was clearly indicated. The 1D8-GT, which combines a triode, pentode and diode in one envelope, was adopted.

The Electric Simplicity-1 was designed to have a pentode R.F. stage, diode detector and triode audio stage. Though the pentode unit of the 1D8-GT was intended for audio output, it worked well as a radio-frequency amplifier, and there was no trouble with feedback. The only precaution necessary was to shield the tube completely.

Two Capinds were wound, one for the

antenna circuit, and one in the plate circuit of the R.F. stage. Capacity coupling was used between the R.F. output and the diode.

The two Capinds were wound on plastic tubes approximately 3/8 inch in diameter, using the methods described in the January issue. An improvement was made in the manner of attaching the flexible lead to the sliding plate. The strip of tinfoil

wrapped around this plate made a closed turn which cut down the inductance of the coil and introduced considerable loss.

The improved connections were made by laying two lengths of fine bare wire lengthwise on the tinfoil cylinder before putting on the outside protective layer of heavy paper. Be sure the contact is perfect. The wire may be sanded and covered with tinfoil.

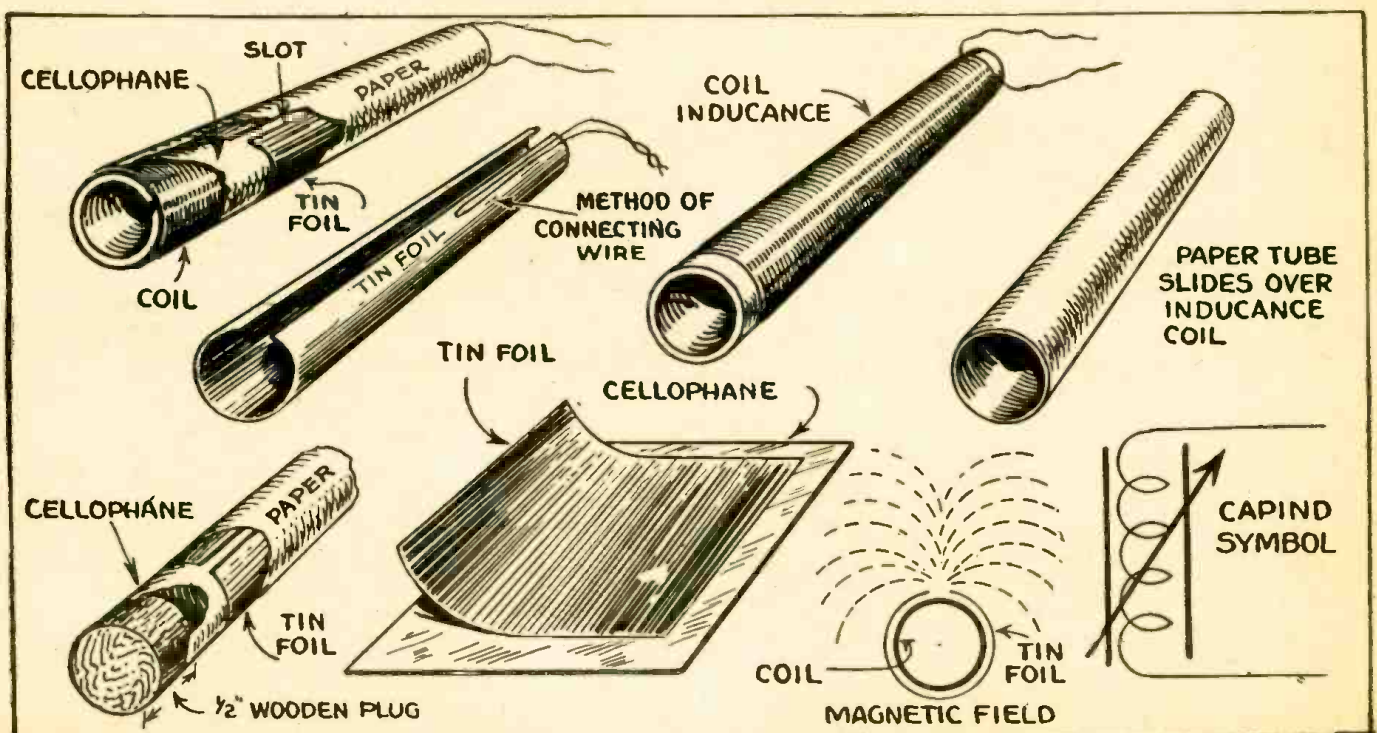

The several steps in the construction of the CAPIND are clearly shown. The two figures at the lower right show the action of the slot in preventing the magnetic field from being entirely enclosed, and the CAPIND symbol.

the reason it was found possible to cover the broadcast band with a smaller coil, only 5 inches of No. 33 wire, (625 turns) being used, instead of the 750-turn coil of the earlier set.

The pentode unit of the 1D8-GT requires a bias of roughly 9 volts. To obtain this it was necessary to insert a "cathode resistor" between the negative filament terminal and the negative end of the power supply. This resistor—100 ohms in value—gave the required bias, and the grid return was connected to its negative end through a 50,000-ohm resistor.

A common "ground" was made at the negative filament terminal and all returns brought back to it, either direct or through condensers. This ground was connected to an outside "ground" binding post through an 0.002-mfd. mica condenser. In many cases a good outside ground improves sensitivity and reduces electrical noise.

An 0.1 mfd. condenser is used to by-pass R.F. from the high-voltage end of Capind No. 2, the plate circuit impedance. An 800-ohm resistor is used in connection with it. The R.F. voltage for the diode plate is taken from the plate end of the same coil through a 250-mmfd. mica condenser. A 50,000-ohm resistor and another 250-mmfd. condenser act as R.F. filter and the lead to the audio grid is taken from the top of the 500,000-ohm load resistor. There was no trouble with stray R.F. or oscillation as long as the tube was shielded.

The audio circuit was hooked up with the conventional 0.01 mfd. condenser and 1-megohm resistor, the triode section of the 1D8 operating at zero bias. In spite of the rather high μ of the tube, signals were loud and apparently free from distortion with phones hooked directly into the plate circuit. Quality was better than in the battery-operated set.

Considerable difficulty was experienced in getting the power supply ironed out. It was necessary to obtain a compact resistor of about 1,000 ohms resistance and 10 watts rating. A 15-watt Mazda lamp was the answer, the exact current being adjusted by varying the input voltage. This was done by increasing or decreasing the capacity of the input condenser. Changing this capacity from 16 to 24 microfarads increased the filament voltage from slightly over 1 volt to practically 1.5, at the same time bringing up the "B" voltage.

Hum persisted no matter what changes and additions were made in the filter system. A 1,000 mfd. electrolytic condenser, rated at 3 working volts, was picked up on

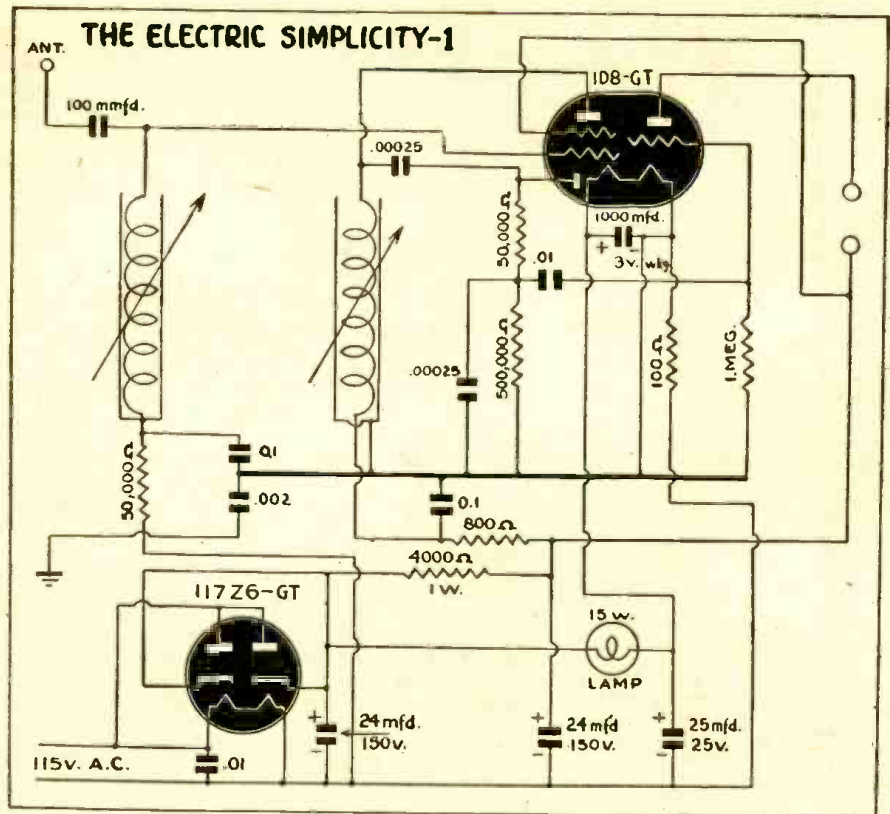

Schematic of the all-electric model. With proper ballast resistors, tubes such as the 25Z5 may be used instead of the 117Z6-GT. Note that an outside ground is used on this set, contrary to the usual A.C.-D.C. practice.

a bargain counter for 49c, and connected directly across the filament of the 1D8. Hum practically disappeared.

A tinfoil shield was placed between the power unit and the receiver proper, as it was thought that their positions on opposite sides of a $\frac{3}{8}$ inch board might introduce hum directly into the receiver. Apparently this was not the case. Grounding the shield or leaving it to float free made absolutely no difference.

Considerable heat is developed both by the 117Z6-GT and the 15-watt Mazda, and plenty of ventilation is needed to prevent overheating the electrolytic condensers.

In accordance with the idea of "Simplicity" no off-on switch was provided. The set is turned on or off like a flatiron, by plugging it into or pulling it out of the

wall socket. Neither is there a volume control—a slight detuning of one of the Capinds being sufficient to reduce volume on loud stations.

The new Simplicity-1 is an improvement over the older one both in quality and volume. Selectivity is also considerably greater, due no doubt to the two tuned circuits. There is still some crowding from high-powered local stations, as might be expected from any 1-tube receiver.

It was noted that this set requires slightly more antenna than the battery-operated model. Used with the short length of wire formerly employed as aerial for the regenerative Simplicity-1, volume was low. A connection from the nearest radiator to the antenna post of the set brought volume up to a very satisfactory level.

ADVICE TO SET OWNERS, OR — HOW NOT TO GET GOOD RADIO SERVICE

1.—Never bring your set to the shop, even if it is a pee-wee midget. You will provide extra employment for the Serviceman by letting him run to and from your home.

2.—Stand over the Serviceman while he is working and give him what advice and encouragement you can. You know more about the set than he does—you've had it longer! If in spite of your help (!) he seems nervous, soothe him as much as possible.

3.—If he tells you that the set must be repaired in the shop, refuse to let it out of your sight. It is easier to bring the shop to the set than to take it to the shop! If it

must go, make him estimate the price of the job before he takes the receiver out of the house. There may be some defective part which he hasn't found with his portable test apparatus. If he finds it with the shop instruments after having estimated the job he will probably replace it free.

4.—Whatever estimate he gives you, squawk like Donald Duck! Don't let him have the job till he gives you a cut of at least 25%. Ten to one he was planning to use unnecessarily high-priced repair parts anyway—so he wouldn't be troubled by a kick-back on his guarantee. He can do it cheaper, and believe you me, if he does, it will be cheaper!

5.—Get your radio back from the shop the same day! The radioman will probably want to play it for several hours after it is repaired, ostensibly to test it, but really for his own amusement and to wear out your tubes so he can sell you new ones.

6.—Never pay on delivery. Tell the man to come back on Saturday, and pay in two installments if at all possible. Probably he overcharged you on the job anyway, and this is your chance to make him earn his money.

7.—NEVER CALL THE SAME SERVICEMAN A SECOND TIME!! He might take revenge for the first job.

HIGH FREQUENCY MEASUREMENTS

By JOHN R. KEARNEY

This article discusses the various theoretical factors to be taken into consideration in the measurement of high frequencies, which more and more is widening in scope due to the greater use being made of high frequencies in various applications.

THE technique used for measuring circuit values at high frequencies is one involving great attention to detail and a constant consideration of probable causes of error. One of the basic measurements is that of determining the surge impedance of a line. In Fig. 1, C1 is adjusted to resonance and then the line is shortened an eighth of a wavelength. The line angle is then $(\pi/4)$, and the reactance of the short section cut out is jZ_0 .

When the reactance of C2, $(1/j\omega C_2)$, is

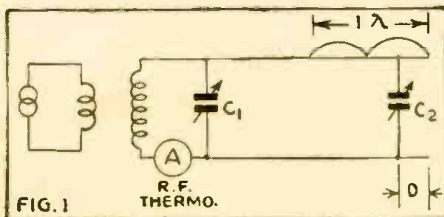

made equal to the reactance of the cut-out section, the surge impedance is equal to Z_0 , and is found by varying the setting of C2 until the circuit is again resonant.

In many cases, the high-frequency value of capacitance differs from the value obtained at a much lower frequency, so that for accuracy the calibration of the standard condenser should be done in the frequency range for which the condenser is used. This is especially important where effective distributed capacity along a line or for a coil is to be determined and where a condenser having other than an air dielectric is being tested.

The absolute electromagnetic unit is the

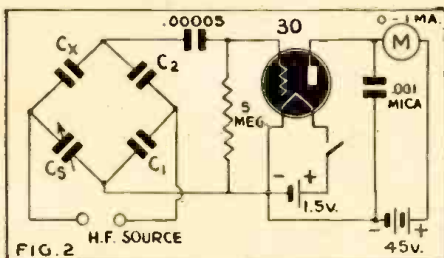

reciprocal of the velocity of propagation of a radio wave, giving the relation, 1 mfd. equals 10 to the exponent -15, per square centimeter, per sec.

This relation is not frequently encountered but is of use when the CL product along an antenna or line is used for evaluating the effective phase velocity. A rather simple straight-forward and accurate circuit is shown in Fig. 2, being designed to measure high frequency capacitance. The bridge circuit is adjusted for zero voltage, tube V1 serving as a gridleak detector. The

fixed standard condensers are C1 and C2. The unknown is Cx and the known standard Cs is adjustable.

A simple method of checking the capacitance, assuming the condenser has low losses, is to use the circuit of Fig. 3. A high frequency generator feeds a current into Cx, with R adjusted to zero. The output of the generator is controlled to give a convenient indication near full scale on the R.F. thermocouple meter, and then R is increased until half-scale current is found. The two impedances are then equal, and $C = 1/R \div \omega$. Under these conditions, the standards are the frequency and the resistance values.

DISTRIBUTED CAPACITY OF A COIL

In Fig. 4, a high-frequency generator sends a current through L1. The coil connected to the generator is loosely coupled to the coil being measured, L2. Standard condenser Cs is tuned for resonance to frequency f1. Its capacitance is C1. The generator is then tuned to the second harmonic, giving f2. Again, Cs is tuned for resonance, its capacitance being C2. The distributed capacity of the coil is then given by the formula $C_0 = (C1 - 4 C2)/3$. Resonance may be indicated by a thermocouple meter connected in series with the tank circuit or by a vacuum-tube-voltmeter connected across Cs.

HIGH FREQUENCY INDUCTANCE MEASUREMENTS

The effective high-frequency inductance of a coil is not the equivalent of the geometrical inductance because the current distribution varies with frequency. The distributed capacity and dielectric losses of a coil also have an effect on its inductive capability. In Fig. 5, standard condenser Cs is adjusted for resonance and the effective inductance of L is equal to the square of $(1/f \div 2\pi) \div Cs$. This would not break down the individual constants of the coil but would show what value of capacitance is required (for resonance) for a given capacitance in Cs. If the value of Cs is made equal to the effective capacitance of the circuit in which the coil is to be used, the information gained from this measurement is all needed for practical purposes.

Such a system would be suitable for production testing. The relative efficiency of two coils would be found by using the circuit of Fig. 6. The Q of the coil is $e2/e1$, the condenser Cs being adjusted for resonance. A vacuum-tube-voltmeter can be used for checking the voltages across the generator and standard condenser.

FREQUENCY ERROR

Frequency error in a vacuum-tube-voltmeter is due to the fact that the impedance

changes as the frequency and the input capacitance forms a shunt admittance, so that a higher value of current is required for operation of the device. If the capacitance is known the error due to frequency shift can be computed by making the assumption that the voltage drops linearly with frequency at the rate of Xc change.

If the leads are kept short and direct, error may readily be compensated. Long leads introduce inductive reactance and resistance. Resonance in the input circuit is to be avoided and the meter in the plate circuit of the tube must be by-passed adequately by a condenser which shows no inductive effects at very high frequencies. Calibration of the vacuum tube voltmeter at very high frequencies is carried out by passing the high-frequency current through a resistance wire of very small diameter and of short length.

In this way errors due to reactance and resistance in the wire are limited, since the

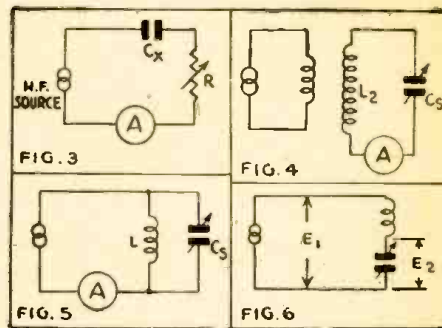

small diameter makes skin-effect changes negligible as frequency is varied, and for the same reason series inductance also varies only by a minute amount. The primary standard is a thermo-couple R.F. meter. Knowing the resistance of the wire (which is practically constant with frequency), and the current in it, the voltage is simply IR. A special separate heater type thermocouple is used. The inductive reactance of the wire is only 1-ohm at 100 megacycles.

Since this inductive reactance is added in quadrature to the resistance, the impedance is increased by only 1 per cent. The details of this arrangement are given in Fig. 7. The standard resistance consists of a Constantin 0.4 mil. diameter wire having a length of 1/16", and the thermo-couple meter is a Cu-Constantin wire 1/8" long, the junction being mounted separately from the heater and in air. If a smaller diameter wire of 0.25 mil. were used, the error at 250 megacycles would be but 1 per cent. The length of the 7-ohm resistor is approximately 1.6 centimeter. The inductance is so small that the unit of inductance used is

the centimeter viz.: $1.6 \div 10$ to exponent 9, of a henry.

CALIBRATION OF THERMOCOUPLES AT ULTRA-HIGH FREQUENCIES

The test circuit for this system is given in Fig. 8. The R.F. current passes through the tungsten lamp filament, making it light up. The light intensity is measured by the micro-ammeter, using the photo-cell for the conversion of light energy into electrical energy. The deflection of the microammeter is proportional to the intensity of the R.F. current. The current also causes a deflection of the thermo-couple meter. We may call this I1.

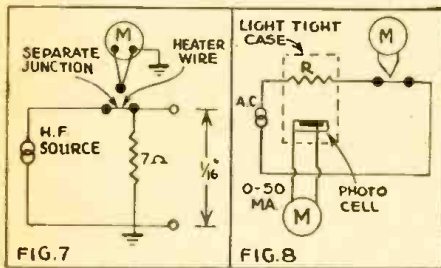

If we now pass a 60-cycle current through R, adjusting the output of the generator for the same deflection as was obtained in the case of the R.F. generator, the microammeter will have a deflection called I2. Then $I1 = I2 \div$ square root of m, where m equals the ratio of effective to calibration frequency resistance. If D.C. is used for heating the tungsten lamp, the correction factors may be obtained from the Smithsonian Physical Tables, 8th ed., pp. 449-451. It is necessary to know the diameter of the tungsten filament.

Changes in temperature will affect the accuracy of delicate measurements, and under such conditions a sort of air conditioning unit may be used, consisting of an insulated box having controllable internal temperature or an ordinary thermos bottle can sometimes be used for housing the thermocouple. The bottle can be packed with cotton to support the thermo-couple junction and to keep out air which otherwise might circulate and affect the measurements. In many instances it is more practical to have a dual thermo-couple system and to pass the A.C. through the heater of one of them, both junctions being connected in series and in opposition, to the microammeter. A change in temperature near the one junction is then compensated for by the same temperature effect in the other junction, the first junction being the carrier of the A.C., and the second junction having no A.C. component present.

MEASUREMENT OF RADIATION RESISTANCE OF AN AERIAL

The radiation resistance can be determined by measurement of the radiated energy flux, the radiation being used for action on a receiving antenna located several wavelengths distant. This is to prevent error due to proximity effect. The effective antenna resistance is first found by using the measurement system of Fig. 10. When half scale deflection on the meter is obtained, the resistance of R is equal to the effective resistance of the antenna. The current is first adjusted with R set at zero and then the ammeter is made to read half-scale by means of R. Knowing the effective resistance, the radiation resistance can be found by the following method. The currents Ia and I1 obtained at resonance are noted. The transmitting antenna is then lowered to 1/10th of its normal height. It is then returned in such a way that the power input is the same as before. That is, $Ia Ra = Ib Rb$.

- where Ra = effective resistance for full antenna length
- Ia = transmitting antenna current for above condition
- Rb = effective resistance for antenna 1/10th of full length
- Ib = transmitting antenna current for above condition

The first receiving current in A2 is I1. Let us call the current in the receiving aerial under the new set of conditions I2. Then the radiation resistance of the transmitting aerial will be,

$$R = \frac{(I1)^2 (Ra) [(Ia)^2 - (Ib)^2]}{(Ia)^2 (I2)^2 - (Ib)^2 (I2)^2}$$

Note that the effective resistance of the antenna when it is cut to 1/10th its normal length is different from the full length resistance, and that a measurement of the antenna when it is cut must be made. The values can be substituted in the above formula for determining effective radiation resistance.

The simplest way to determine frequency on the ultra-highs is to use an arrangement such as shown in the sketch. A pair of copper tubes having a length of 6 ft. will be suitable for frequencies in the vicinity of 300 megacycles and higher. The tubing should be heavy for the sake of rigidity

and for stability of measurements, and is mounted on heavy standoff insulators. A sliding bar consisting of a flat copper strip 1/16" thick, secured to the two collars, permits easy adjustment. A coupling coil is

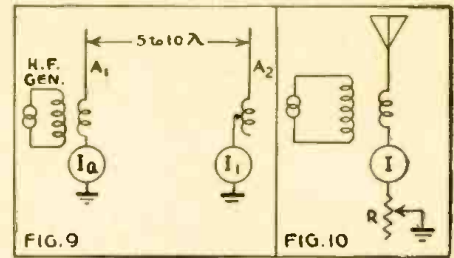

connected at one end, and the other end of the line is left open.

ULTRA-HIGH FREQUENCY LECHER SYSTEM

A signal generator of unknown frequency may be coupled to the coil. The generator should have a plate-current meter. As the bar is slid along the tubing, a point will at last be reached where the generator plate current will rise, indicating resonance and absorption of power. This point may be marked on the tubing, or the power can temporarily be switched off and a steel tape can be used for measuring the length of the distance between the bar and the open end of the line. This figure is noted. Then the bar is again moved in the direction of the coil until a second point of resonance is found. The bakelite rod is used to avoid disturbing the tuned line. It is mounted by means of a tap in the rod, a machine screw

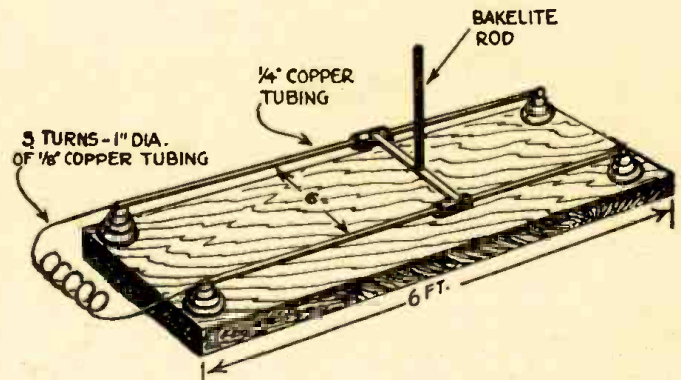

holding the rod to the copper shorting bar. The system should be kept in the clear and as far distant from surrounding stray fields and metal as is practicable under ordinary circumstances. The distances between nodes will represent half a wavelength.

"ESSENTIALITY" BASIS FOR SERVICING

RADIO and appliance dealers, servicemen and distributors, in a recent meeting held in New York City, heard officials of the Office of Price Administration and the War Production Board discuss and explain regulations governing repairs and servicing.

Peter Ripps, regional unit chief of services of OPA, spoke forcefully about the fact that servicing from now on must be based on "Essentiality". He stated that OPA has defined the term "Essential Service" as: "The maintenance of the civilian standard of living consistent with the successful prosecution of the war."

With services restricted to those considered essential, we unquestionably will find many peacetime frills eliminated. Probably, as the war progresses, only those services vital to health and morale will be allowed to

continue. Surely radio, as a bastion of home-front well-being, should and will be classified as essential.

REPAIR PARTS

Interesting comments on the availability of repair parts for radio and appliance servicing were made by Sterling A. Warren, chief of the miscellaneous section of the distribution division of WPB. He gave assurance that every effort is being made to keep essential equipment in operation, and that by the same token the necessity of supplying parts is well recognized. Mr. Warren declared, "I can assure you that you can be reasonably certain that all such essential servicing will get all possible preferred attention, although we can make no outright predictions at this time."

PD-IX FORMS

Mr. Warren went on to explain the necessity of distributors' using PD-IX forms in applying for repair and replacement parts. He emphasized, however, that even complete and intelligent use of these forms does not automatically assure distributors of getting deliveries. This point was stressed when, at first, dealers and servicemen seemed to have the impression that the reason replacement parts were not available to them more quickly was the failure of distributors to use the proper forms.

PD-IX applications, when approved, will assist the distributor in obtaining parts only to the extent that merchandise is available on the priority rating assigned.—*Sylvania News*

R.F. CARRIER COMMUNICATIONS

By WERNER MULLER
PART I

IN the following article the use of old ideas, but brought up to date, will be thoroughly discussed. The aim is to enliven the use of R. F. Carrier superimposed on various media for the purpose of transmitting various forms of intelligence.

We probably all know that the Radio Frequency Carrier field has been badly abused, false claims have been made; tall stories have been written in general; and the possibilities have been theoretically highly exploited. Some of the ideas have worked, and some others have not fared as well. It seems that the latter above statement was more prevalent, since the use of R.F.C. has dropped from the open market into a rather limited field. Truthfully speaking there is no real reason for this, because the use of Radio Frequency Carrier systems is very varied and the applications are large. True there are sometimes difficulties, but in most cases by intelligent engineering these sick cases can usually be overcome. Perhaps, so as not to cover too much territory, let it be said that R.F.C. for industrial purposes has almost endless applications; for the commercial field, the uses although many, are limited. This factor was proven a few years ago, when the writer made an extremely thorough survey throughout the U. S. A. in regards to the use of R.F.C.

Knowing this fact, we shall stick to the industrial field—since sound business is here most readily obtainable.

Some of the most important uses of R.F.C. shall now be classified, and then in turn, each classification will have a complete text of its own covering all necessary angles.

There are three Groups of Transmission media available to R.F.C.

1. Powerlines
 - a. A.C. Lines
 - b. D.C. Lines
 - c. A.C. High-tension
 - d. D.C. High-tension
2. Telephone Line (all types of service)
 - a. A.T.&T. Lines (Not Usable)
 - b. Privately-owned lines
3. Highly-Conductive Metallic-type Structures
 - a. Conduit Lines
 - b. Rail Lines
 - c. Iron Lines
 - d. Pipe Lines

These three groups represent those media most commonly encountered in industry. Each group has certain peculiarities and definite uses and limitations. But for the most part they are tremendously useful. At present R.F.C. is not so universal as one might think, and as already mentioned it was the theoretical abuse that was responsible for this unpopularity.

Next we come to breaking down the classifications of the various groups into their respective functions.

POWERLINES

As will be noted, small subdivisions are used. *A.C. Lines, (Subdivision A)*, is the first subject. Alternating-current lines up

With this article the author begins a series of interesting and authoritative discussions of R. F. Carrier Communications in all its phases—over power lines, telephone lines, and ground lines—including the difficulties to be overcome. In no



other magazine will there be found the complete and exhaustive treatment of the subject that Mr. Muller gives here. We urge all wide-awake experimenters and constructors to watch for these articles monthly.—The Editors

to 220 Volts A.C. do not present too difficult a problem. Individual parts are within the normal price range, and costs can be kept low. On lines from 220 Volts to 660 Volts A.C., costs increase slightly, and additional safety factors must be observed.

R.F.C., when used here, can be pulsed, keyed, tone-modulated, or speech-modulated. Distances up to seven miles can be readily worked, without using excessive power in the R.F. final. Power output of 6-8 watts R.F. Carrier is sufficient for practically all forms of transmission.

D.C. Lines (Subdivision B). Where D.C. power lines only, are available, problems of proper transmission are more pronounced. The chief problem is due to the character of the lines with respect to the R.F. itself. That is, little impedance is offered. In fact, it is usually so low that matching is almost impossible. Loading of the lines by an electrical device—heaters, motors, etc.—will almost act as a short-circuit across the terminals of a transmitter, especially if the devices are located near the transmitter. (In A.C. circuits this problem does not enter, or rather, it is negligible with respect to the terminal impedance of the transmitter.)

A.C. and D.C. High-tension (Subdivisions C. and D). Transmission on lines carrying over 660 Volts entails only one factor—or one method of coupling. Let it be inductive, or capacitive, or a combination of both, but cost is the main problem, since the required safety factors are of the highest order, thus bringing up the expenses; but regardless of the additional costs, the benefits to be derived will more than balance the expense in the long run.

IMPEDANCE MATCHING

It was mentioned above that in connection with A.C. circuits the problem of transmitter short-circuiting does not occur. This is true, of course, only if the transmitter output circuit is of the low-impedance type or of the link-coupled type. If the transmitter output impedance is high—say 25 ohms or higher—then loading effects are important, because reflections will take place, causing mismatch of the output circuit.

This peculiarity was observed and studied and analyzed. The results obtained brought to light the following facts: Of the two existing forms of transmission—high-voltage low-current, and low-voltage high-current—the latter seems to be the proper approach in solving the loaded line problem, that is, on A.C. lines. This resulted in constructing transmitters with low output-impedances, ranging from 2-15 ohms.

The improvement obtained in eliminating load reflections was considerable, and was almost universally followed by most manufacturers. But it was far from perfect, and more and more research had to be done.

It was toward the end of 1937 that a new theory was advanced and the results achieved were startling. Link coupling—used commonly in transmitters—was adapted to the output of a carrier-type transmitter.

The theory was, to regard an A.C. line as a link circuit, that is, a link circuit between the transmitter and receiver. Since a link circuit has negligible impedance the A. C. line was looked upon as such a link, and the usual *characteristic impedance* was disregarded. Of course impedance still existed, but any *change of the impedance*, due to varying loads, was negligible with respect to the output of the transmitter, since the output circuit consisted of only a few turns.

Actual impedance measurements were made at the time, but the exact value was not determined. It seemed to hover between 0.05 to 0.50 ohms. The amazing performance was noticed that loading the line with a pure resistive load (heater elements) as high as 2K.W., direct across the transmitter output, had no noticeable effect on the power output of the transmitter.

It was these results that produced a transmitter incorporating link coupling features, and this transmitter operated over 10 miles of A.C. lines, bridging line-transformers and other devices. Perfect communication was established.

Using this same system on telephone superimposed lines, two-way conversations over a distance of 170 miles without repeaters, and with very low field-intensity from the telephone lines radiated, was carried on with excellent performance, surpassing the telephone itself. Cross-talk and interference was no problem.

Continuing this theory, on D.C. line application, excellent results were obtained in the coal-mining industry. Research established perfect contact over seven miles un-

(Continued on page 379)

WATCH ★ ★ ★ ★ MIDWEST

AFTER THE WAR IS WON ★ ★ ★
FOR SENSATIONAL ADVANCEMENTS
AND FEATURES SUCH AS . . .

SUPER BAND - SPREAD TUNING*

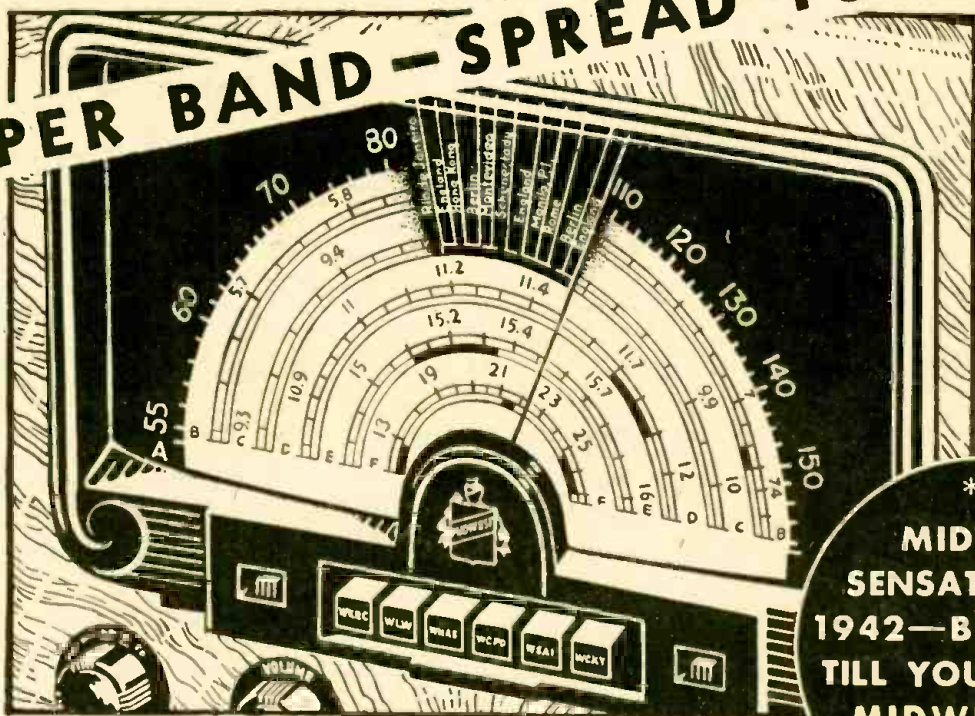

***A
MIDWEST
SENSATION IN
1942—BUT WAIT
TILL YOU SEE THE
MIDWEST OF
TOMORROW**

OUR ENTIRE PRODUCTION FACILITIES
ARE NOW DEVOTED TO MANUFACTURING
RADIO EQUIPMENT FOR OUR ARMED FORCES
BUT...WHEN VICTORY IS WON

**YOU'LL BE BUYING YOUR MIDWEST RADIO
DIRECT FROM THE FACTORY**

SAVING UP TO **50%**
WILL BE JUST AS POPULAR AS EVER

Yes, Sir. Thousands upon thousands of people all over the U. S. were buying super powerful Midwest Radios direct from our factory until "Pearl Harbor" and if the many letters we are still receiving every day is an indication, the direct-to-user-plan will be more popular than ever after the War is won.

FOR VICTORY

**BUY
UNITED
STATES
WAR
BONDS
AND
STAMPS**

FREE

**FOR A
LIMITED
TIME ONLY**

THIS comprehensive 20-page booklet on our Armed Forces absolutely free if you send 10¢ for a U.S. War Savings Stamp. Just send 10¢ in coin or postage stamps and your booklet and War Savings Stamp will be sent promptly.

MIDWEST RADIO CORPORATION
DEPT. 12-B **CINCINNATI, OHIO**

THE "YA MEI" MULTITESTER

By FRED SHUNAMAN

This versatile little unit makes 18 tests on D.C., A.C., and Ohms, with a two-gang, 11-position switch. Built around a 1.5-milliampere meter it can readily be adapted for use with meters ranging from 0.5 up to 3 milliamperes.

THIS tester is a genuine junk-box job. It was built from what parts were available, and for that reason may be unconventional in spots. It is as good a performer as any meter I have ever used. It measures voltages from 7.5 to 750 in ranges of 7.5, 15, 75, 150 and 750 volts, either A.C. or D.C. Current ranges of 1.5, 15, 75, 150 and 300 milliamperes are provided, and there are three ohmmeter ranges, permitting measurement of resistors from 1 to 300,000 ohms. With the help of a 0.5 condenser, it acts as an output meter and can be used as such in aligning receivers.

The multitester was built around a Ferranti 1.5 ma. meter, a D.P.D.T. toggle switch, a cheap copper-oxide rectifier, and a two-gang, 12-point switch. This latter was manufactured by the Asiatic-American (Ya Mei) Radio Company of Shanghai, otherwise known as the Amateurs' Home. Hence the name of the unit.

The 1.5 meter was used because it was the best thing for the job I had at the time. Although there is a tendency toward lower and still lower-reading meters, there have been no difficulties in the use of this instrument. Most readings that cannot be made with it cannot be made satisfactorily with a 1-ma. movement, and require a vacuum tube voltmeter. The important thing is to know what you are measuring and to consider the possible effect of the meter on the measurement. Then you cannot be misled by the readings.

CONSTRUCTION OF TESTER

The first step is to mount the parts on the panel. I would not advise the reader to attempt as compact a job as this one, at least not as a first try. This was the third tester we had constructed within a few months, and the little case—made for another job—was all too available. Even at that there was plenty of grief on account of the compactness. Some of the disadvan-

tages of trying to make too small an instrument remain to this day.

Mount the meter first, then the pin jacks, the variable resistor for ohmmeter, the zero adjustment, the toggle and gang-switch, and the rectifier. The meter is then connected to the center arms of the D.P.D.T. switch, and the incoming A.C. and D.C. leads are connected to the arms of the gang-switch.

This hook-up makes it possible to get both A.C. and D.C. readings with a two-gang switch, and is one of the reasons why we can get 18 ranges with 11 switch-positions.

It was necessary to provide three sets of pin-jacks in order to cover all the ranges. Those on the left are A.C. voltages. The pair on the right cover D.C. voltage and current, and two ohmmeter ranges; while the two at the top of the meter are used for measuring low-ohms and for the 1.5 ma. scale.

A connection from the A.C. switch arm to the D.C. negative jack makes it possible to use the switch for milliammeter and ohmmeter readings. With the exception of the five A.C. voltage ranges, all readings are D.C. The change from one to the other is made by the toggle switch, the "up" position covering A.C. voltages, and the "down" being used for all other tests.

VOLTAGE RANGES

The next step in the construction of the meter was wiring up the voltage ranges. The voltmeter resistors are calculated, according to Ohm's law, at 667 ohms per volt. The 750-volt range uses a 500,000 ohm resistor, the 150-volt range a 100,000 ohm resistor, etc.

Analysis of current flow is as follows: With the positive D.C. test lead on the positive terminal of the voltage source and the negative D.C. lead on the other side, the current course is as follows: To the D.C. switch arm, through the resistor selected by it, and down the common positive lead through the D.P.D.T. switch to the meter, and directly to the negative terminal. (Note well that this is the old-fashioned current that moves from positive to negative, not the new radioman's electronic stream which always goes in the opposite direction!)

A.C. VOLTAGES

The arrangement on the A.C. side is a little different. The resistors are only 90% of the value calculated by Ohm's law. This is because a D.C. meter reads only 90% of the effective value of rectified alternating current. By cutting down on the resistors, we compensate for this, and the meter reads the same on A.C. as on D.C.

Before A.C. readings can be taken, the meter has to be switched across the rectifier, REC., using the D.P.D.T. switch. Analysis of current flow is as follows:

With the switch in the A.C. position ("up"), alternating current enters through one of the A.C. pin jacks to the A.C. switch arm, through the selected resistor, to the rectifier and out the other A.C. pin jack terminal. The rectified component of this current then goes through the meter and completes its circuit back to the rectifier.

CALIBRATION

The set was calibrated over the various scales by comparing with a standard for one of the ranges—then making the other ranges agree with it. The value chosen for the A.C. ranges was 120 volts. This point can be found readily, either from the local electrician, a laboratory or a trip to the nearest power station. Setting this at 1.2 on the meter, we have a zero to 150-volt scale. It is then possible to adjust the 75-volt scale. A voltage that reads "1.2" on it will read "0.6" on the 150-volt scale. One hundred and fifty volts reads full scale on the range where we have the 120-volt point, and "0.3" on the 750-volt scale.

It is usually easy to get a standard for the D.C. scales, but if no accurate voltmeters are available a rough calibration may be made with two good "B" batteries—assuming the voltage to be 90.

MAKING RESISTORS FIT

The actual adjustment was done chiefly with a file. It was necessary to save as much space as possible, so resistors of odd values could not be made up of two or three units. If it was necessary to have a 45,000-ohm resistor, a 40,000-ohm carbon resistor was chosen and reduced in size till the meter calibrated properly. A few wire-wound Davohms which were left from some ancient resistance-coupled amplifier were used to good advantage, all the low-range resistors being wound from them. It was possible to wind them to the exact resistance without trouble, and they were very compact.

RECTIFIER TROUBLES

The 7.5-ohm resistor on the A.C. side cannot be wound according to calculations, at least not with the rectifier used in this set. The rectifier itself has so much resistance that it is necessary to wind the external resistor experimentally, increasing the resistance from zero till the meter calibrates correctly.

A certain lack of linearity was evident on this range, so the resistor was adjusted to give readings as near correct as possible at 6.3 and 2.5 volts, the other points being let fall where they would. This was the only scale where non-linearity of the A.C. readings gave any trouble. The reason was, no doubt, that most of the resistance in this scale was in the meter, so that small changes of meter resistance caused large percentage differences in the circuit. On the higher ranges practically all the re-



The Ya Mei multitester. Test leads are shown in the D.C. jacks.

sistance in the circuit is in the external resistor, and errors introduced by the rectifier are negligible.

THE OHMMETER CIRCUIT

The high-ohm range reads to about 200,000 ohms. Voltage is supplied by three large flashlight cells, which have lasted more than three years without renewal.

The current flow in the ohmmeter circuit is as follows: From the positive terminal of the battery through the 1,500-ohm variable resistor, through the fixed 2,000-ohm resistor, through the meter, and out the negative terminal to and through the resistor to be measured. Then back to the positive D.C. pin jack and through point 6 on the gang-switch, to the negative end of the battery.

The medium range was made by shunting a resistor of slightly more than 300 ohms (made from the old Davohm) across the variable and fixed resistors and the meter. Now the current has two paths, the same one as before, and a new one—through the shunt, through the resistor under test, and back to the battery. By carefully removing turns of resistance wire from the shunt till it reaches the right value, the medium-ohms scale can be made to fall right on top of the high-ohms scale; 1,000 ohms on the medium being the equivalent of 10,000 on the high. Nine-tenths of the current from the battery goes through the shunt and the unknown resistor, and only one-tenth goes through the circuit with the meter in it.

THE SHUNT OHMMETER

Low-ohm resistors are measured across the pin jacks at the top of the instrument. These are connected direct to the positive and negative terminals of the meter. The D.C. positive and negative pin-jacks are short-circuited and the zero adjustment made with the 1,500-ohm variable resistor. Then the unknown low-ohm resistor is connected to its jacks.

The meter is a shunt-type instrument when used on this range, and the readings are in the opposite direction from those of the high-ohm and medium-ohm ranges. The low-ohm range was calibrated in a few minutes with the help of a decade box with resistors from 1 to 1100 ohms, in 1-ohm steps.

These two terminals are also used for the 1.5-ma. scale. To avoid possible accident, the switch may be turned to one of the high-voltage scales during measurements on this range.

Points 8 to 11 on the gang switch are milliamperage ranges. The internal resistance of this meter is 60 ohms. This was discovered by setting the meter to full scale with the help of a variable resistor and a dry cell, then shunting various resistances (from the decade box) across the meter terminals till it dropped to half scale. Since half the current is flowing in each circuit, the external resistor must be equal to the resistance of the meter, and the external resistance read 60 ohms.

To get a reading of 15 milliamperes we need 10 current paths, each one with the same resistance as the meter. Then one-tenth of the current, or 1.5 ma., will flow through the meter and the other nine-tenths will flow through the external shunt. In other words, to get a 15-ma. reading (or to multiply the meter range 10 times), we have to have a shunt 1/9th the resistance of the meter. To multiply the meter range 100 times, the shunt would have to be 1/99th of the meter resistance, etc.

Our 15-milliamperage shunt, by this calculation, had to have a resistance of 6.67 ohms. The 75-milliamperage shunt (1/49th the resistance of the meter) was roughly 1.2 ohms.

D.C.		A.C.
1	250 volts	1
2	15 volts	2
3	75 volts	3
4	15 volts	4
5	75 volts	5
6	High Ohms	—
7	Medium Ohms	—
8	300 M.A.	—
9	150 M.A.	—
10	75 M.A.	—
11	15 M.A.	—

“DOWN” Switch Position “UP”

OHMMETER			
100	13.5	2,000	8.7
200	13	3,000	6.75
300	12.75	4,000	6
400	12.5	5,000	5.5
500	12	7,500	4.5
600	11.5	10,000	3.3
700	11.25	15,000	2.5
800	11	25,000	1.5
900	10.75	50,000	0.8
1,000	10.5	100,000	0.3

This chart is glued to the bottom of the case. Ohmmeter readings are "for example only" of course.

These were cut to the approximate size from a spool of fine nichrome, and adjusted till they were right. Nichrome wire was used for all the shunts, several of the fine wires being twisted into a cable for the higher ranges.

Copper wire could have been used, but it changes resistance with changing temperature, and the nichrome made shorter and smaller shunts possible. It is hard to solder, so the connections were made by twisting the nichrome wire around the lugs of the switch firmly to make a good electrical connection, then flowing in solder and rechecking to see that the conductivity of the shunt had not been changed by the soldering. The connection between the solder and the

nichrome is purely mechanical, so the contact lugs must be well cleaned and an excellent soldering connection made to them. If this is done the nichrome will have great difficulty in getting away.

OUTPUT METER

One of the pin jacks at the top was originally connected to the top A.C. terminal through a condenser and used for output measurements. The output meter was abandoned in favor of the low-ohm range. When it is necessary to measure output, the meter is connected up to the output circuit under test through a 0.5 mfd. condenser, and the switch set for the A.C. range which gives the best results.

The only change necessary to adapt this multimeter to a 1-ma. meter is to use a 3-volt battery in the ohmmeter instead of the present 4.5 volt one, or to increase the total resistance in the ohmmeter circuit from the present 3,000 ohms to 4,500 ohms. Milliammeter shunts have to be adjusted to the internal resistance of the particular meter.

If used with the present voltmeter resistors, the top voltage reading will be 500 volts instead of 750 volts, and so on down the other ranges. There is no reason why a 2-ma. meter should not be used, with slight changes to suit the user.

It will be noted that no marks were made on the scale of the meter. It is marked with only one range—0 to 1.5 milliamperes, calibrated at 0.1, 0.2, etc., milliamps. For the 1.5, 15 and 150-volt or milliamperes scales, the reading is direct. Readings are multiplied by 5 for the 7.5, 75 and 750 scales and doubled for the one 300 (milliamperes) scale.

The same is true of ohms. A chart giving the ohms for each milliamperes reading on the scale is attached to the bottom of the meter. This is good for the high- and medium-ohms scale. The low-ohms scale, not so often used, is kept on a piece of paper in a drawer. A typewritten chart was found more convenient than a graph.

Attached to the bottom of the meter is a sheet showing the range for each setting of the switch. Probably it would be much better to have the switch-plate engraved, but as stated at the beginning of the article, this is a genuine junk-box set.

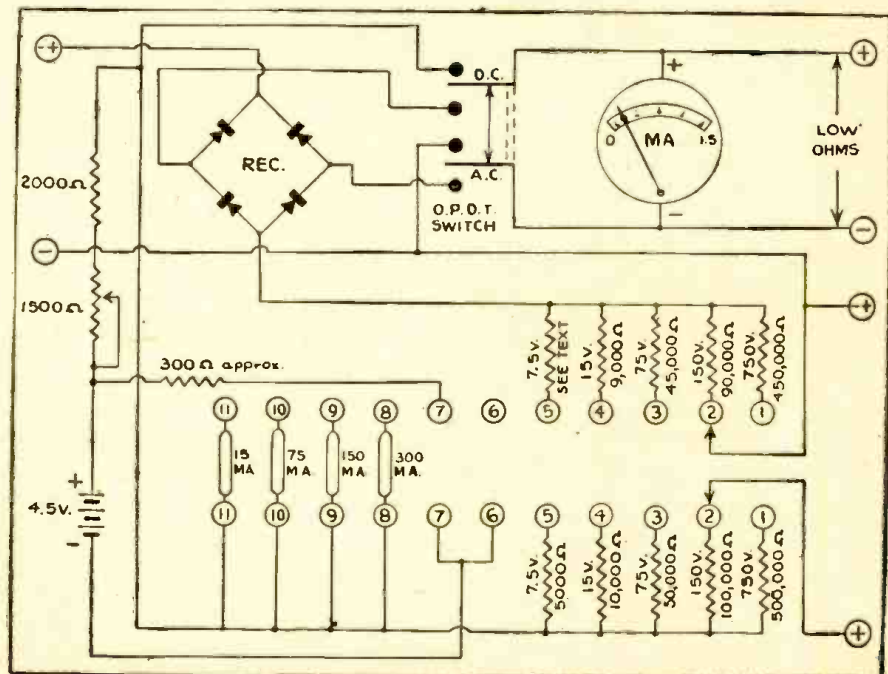

Maximum of function with minimum of parts is made possible by using one side of the gang switch for D.C. and the other for A.C., and by the ingenious cross-over connection between the two circuits.

CROSLY MODELS O2CA AND O2CB

Ten-Tube, 3-Band, Superheterodyne Receivers for A.C. Supply

SETTING THE PUSH BUTTONS
(Station Selector)

The six station selector push buttons are set by means of two adjusting screws per button. These adjusting screws are made accessible by removing the station selector push button escutcheon. Pry off carefully, being careful not to scratch the main escutcheon.

Select the call letter tabs of your six favorite broadcast stations from the station call letter sheets supplied. Place the call letter tabs in the window above that push button which is to be adjusted for that station. It is not essential that all push buttons be set at one time.

Note: When placing call tabs in the window, be sure to arrange them according to their frequency (kilocycles), that is: the station whose frequency is well within the range covered by the No. 1 button, should be placed above that button and so on with the rest of the buttons to be set. After tabs are in place, break off the celluloid covers from the strip furnished and snap in place over the call letters to protect and hold them in place.

SET-UP PROCEDURE

Remove station selector push button escutcheon. Turn the receiver on and let it operate for a sufficient length of time to permit the tubes to reach their normal operating conditions.

Note: To simplify the set up and insure accu-

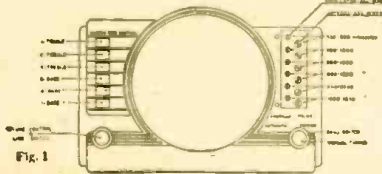

rate adjustments, the following pre-adjustments should be made.

Tighten all Antenna Trimmer screws moderately tight. See Fig. 1. Turn the Oscillator adjusting



Crosley Model O2CA

screws to the left (counter clockwise) until the threaded portion extends approximately 1/4 inch.

Note: Care should be taken when adjusting the oscillator: screws so that the selected station is not passed over. Turn the screws slowly.

It is essential that the frequency (kilocycles) of the station selected is within the range of the push button to be set for that station. See Fig. 1.

1. Turn the band change switch to the "American" position. Using the station selector knob, carefully tune in the station to which the No. 1 push button is to be set. Note program.

2. Turn the band change switch to the "Automatic" position and, using a small screw driver, carefully turn in a clockwise direction the Oscillator adjusting screw until the station previously tuned in manually is heard again. Adjust for maximum output in the speaker.

3. Adjust the Antenna adjusting screw for maximum volume in the speaker.

4. Turn band change switch from "Automatic" to "American" and back again to check if adjustment has been correctly made. There should be no change in tone quality when switched from one to the other.

5. Repeat above procedure for the remaining push buttons.

To tune the receiver with the push buttons, set the band change switch on "Automatic" and depress completely the button corresponding to the station you wish to hear.

PHONO-CONNECTIONS

The chassis is so constructed as to be adaptable to a phonograph pick-up (high impedance type) for the reproduction of recordings.

The connecting terminals provided may also be used for the reproduction of television sound or FM programs if proper converter units are used. Connections should be made as shown in the diagram.

Note: The jumper wire between terminals must be removed when phono radio switch is connected. If phono radio switch is removed it is essential

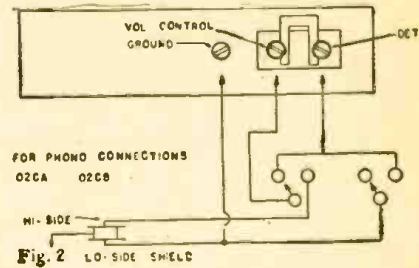

that the jumper wire be replaced. Be sure all connections are tight.

The P-K screw located to the left of the phono-terminal board is the ground or low-side connection.

ALIGNMENT PROCEDURE

- Preliminary Output Meter Connections—Plate to Plate of 6AC5G's
- Generator Ground Connection—To chassis or Ground Lead
- Dummy Antenna to be in series with generator output—See Chart Below
- Position of Volume Control—Fully On
- Position of Master Tone Control—All Buttons Out

IMPORTANT ALIGNMENT NOTES

When aligning the shortwave bands "OSC" trimmers care must be exercised to see that the circuits are aligned on the correct frequency and not on the image which is approximately 910 kilocycles less as indicated on the Receiver dial.

To check, increase generator output, tune-in the generator frequency and then tune-in the image frequency which should be weaker than the fundamental and come in approximately 910 kilocycles lower on the Receiver dial than the fundamental. If image cannot be tuned-in, the "OSC" trimmer is adjusted to the wrong peak. (Correct peak is the second peak on trimmer from the closed position.)

ALIGNMENT PROCEDURE CHART

Alignment Sequence	Dummy Antenna	Frequency Setting	Input Connection to Receiver	Band Switch	Tuning Cond. Setting	Trimmer Adjusted	Remarks
1.	.02 MF.	455 Kc.	Stator lug Rear section of Gang Cond.	B. C.	Fully open	2nd I.F. (2) 1st I.F. (2)	Adjust for maximum. Adjust for maximum.
2.	.0002 MF.	1630 Kc.	Ant. Terminal	B. C.	Fully open	B.C. "OSC" Trimmer	Adjust for peak; gang does not have to tune through signal. Loop must be connected.
3.	.0002 MF.	600 Kc.	Ant. Terminal	B. C.	Approx. 60 on dial	B.C. "OSC" Series Trimmer	Adjust for maximum output while rocking gang through signal.
4.	Repeat Step No. 2 to check possible shift due to series adjustment.						
5.	.0002 MF.	1400 Kc.	Ant. Terminal	B. C.	Approx. 140 on dial	B.C. "ANT" Trimmer, B.C. "R.F." Trimmer	Adjust for maximum output do not touch B.C. Osc. Trimmer. Adjust for maximum output.
6.	400 ohm (carbon)	5.3 Mc.	Ant. Terminal	Police	Fully open	Pol "OSC" Trimmer	Adjust for peak; gang does not have to tune through signal.
7.	400 ohm (carbon)	5.0 Mc.	Ant. Terminal	Police	Approx. 5.0	Pol "ANT" Trimmer	Adjust for maximum output.
8.	400 ohm (carbon)	18.3 Mc.	Ant. Terminal	S. W.	Fully open	S.W. "OSC" Trimmer	Adjust for peak. Gang does not have to tune through signal.
9.	400 ohm (carbon)	18.0 Mc.	Ant. Terminal	S. W.	Approx. 18	S.W. "ANT" Trimmer	Adjust for maximum output while rocking gang through signal.
10.	Repeat the above alignment procedure for more accurate adjustments. Always keep signal generator output as low as possible to prevent action of the A.V.C. circuit.						

Radio Service Data Sheet

331

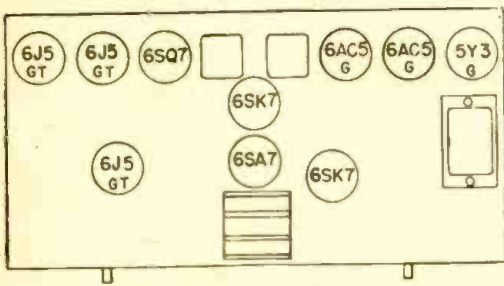

Tube Layout

TUNING RANGES
 American broadcast band—
 540 to 1630 KC (555 to 184
 Meters)
 Police, Amateur, etc.—
 1600 to 5200 KC (187 to 57.5
 Meters)
 Short Wave (Foreign)—
 5.2 to 18.0 MC (57.5 to 16.6
 Meters)

TUBES
 2—6SK7, 1—6SA7, 1—6SQ7,
 3—6J5, 2—6AC5GT, and 1—
 5Y3G. (Tubes may be metal
 or Bantam [GT] equiva-
 lents.)

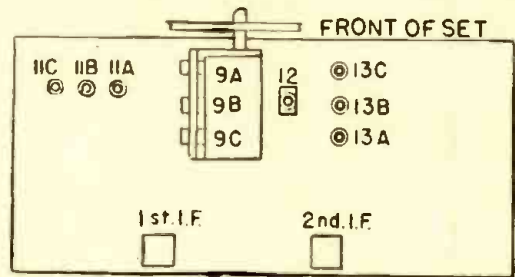

Trimmer Location

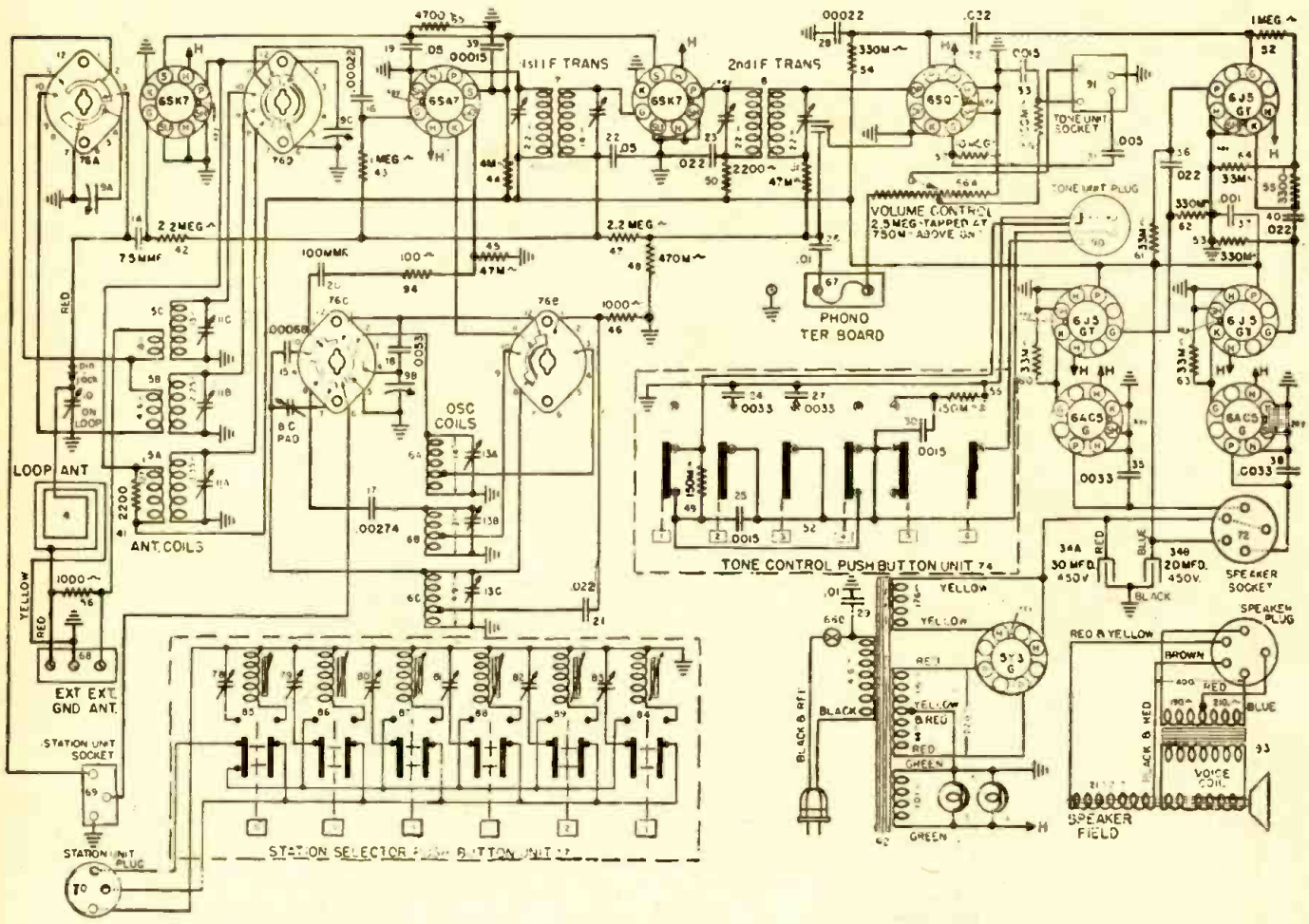

WIRING DIAGRAM, MODELS 02CA AND 02CB — CHASSIS MODEL No. 55

Parts List

Item No.	Description	Item No.	Description	Item No.	Description	Item No.	Description
1	Dial Light	18	.0053 Mf. Cond.	44	4000 Ohm 3 W. Res.	70	Cable & Plug—Sta. Selector
2	Dial Light	19	.05 Mf. 400 V. Cond.	45	47000 Ohm ¼ W. Res.	72	Socket Speaker
3	Power Cord and Plug	20	100 Mmf. Cond.	46	1000 Ohm ¼ W. Res.	74	Tone Sw. Assembly
4	Antenna Loop	21	.022 Mf. 200 V. Cond.	47	2.2 Megohm ¼ W. Res.	75	(No part listed)
5A	B. C. R. F. Coil	22	.05 Mf. 200 V. Cond.	48	470,000 Ohm ¼ W. Res.	76A	Band Chg. Sw. Ant. Sec.
5B	Pol. Band Ant. Coil	23	.022 Mf. 600 V. Cond.	49	150,000 Ohm ¼ W. Res.	76B	Band Chg. Sw. Osc. Sec.
5C	S-W Ant. Coil	24	.0033 Mf. 600 V. Cond.	50	2200 Ohm ¼ W. Res.	76C	Band Chg. Sw. Sec. Sec.
6A	S-W Osc. Coil	25	.0015 Mf. 600 V. Cond.	51	47,000 Ohm ¼ W. Res.	76D	Band Chg. Sw. R. F. Sec.
6B	Pol. Band Osc. Coil	26	.01 Mf. 200 V. Cond.	52	1 Megohm ¼ W. Res.	77	Sta. Selector Assem.
6C	B. C. Osc. Coil	27	.0033 Mf. 600 V. Cond.	53	330,000 Ohm ¼ W. Res.	78	Trimmer—Sta. Sel.
7	1st I. F. Trans.	28	220 Mmf. Cond.	54	330,000 Ohm ¼ W. Res.	79	Trimmer—Sta. Sel.
8	2nd I. F. Trans.	29	.01 Mf. 120 V. A. C. Cond.	55	3300 Ohm ¼ W. Res.	80	Trimmer—Sta. Sel.
9A	Var. Cond. Ant. Section	30	.0015 Mf. 600 V. Cond.	56	1000 Ohm ¼ W. Res.	81	Trimmer—Sta. Sel.
9B	Var. Cond. Osc. Section	31	.005 Mf. 600 V. Cond.	57	10 Megohm ¼ W. Res.	82	Trimmer—Sta. Sel.
9C	Var. Cond. B. C. R. F. Sec.	32	.022 Mf. 400 V. Cond.	58	150,000 Ohm ¼ W. Res.	83	Trimmer—Sta. Sel.
10	Ant. Loop Trimmer	33	.0015 Mf. 600 V. Cond.	59	150,000 Ohm ¼ W. Res.	84	Coil—Sta. Sel.
11A	B. C. R. F. Coil Trimmer	34A	30 Mf. Elect. Cond.	60	33,000 Ohm ¼ W. Res.	85	Coil—Sta. Sel.
11B	Pol. Band Ant. Trimmer	34B	20 Mf. Elect. Cond.	61	33,000 Ohm ¼ W. Res.	86	Coil—Sta. Sel.
11C	S. W. Ant. Coil Trimmer	35	.0033 Mf. 600 V. Cond.	62	330,000 Ohm ¼ W. Res.	87	Coil—Sta. Sel.
12	Padder Cond. B. C. Osc. Coil	36	.022 Mf. 400 V. Cond.	63	33,000 Ohm ¼ W. Res.	88	Coil—Sta. Sel.
13A	S. W. Osc. Coil Trimmer	37	.001 Mf. 600 V. Cond.	64	33,000 Ohm ¼ W. Res.	89	Coil—Sta. Sel.
13B	Pol. Band Osc. Coil Trimmer	38	.0033 Mf. 600 V. Cond.	65	4700 Ohm 2 W. Res.	90	Cable & Plug—Tone Sw.
13C	B. C. Osc. Coil Trimmer	39	150 Mmf. Cond.	66A	Vol. Control 2.5 Megohm	91	Socket—Tone Sw.
14	75 Mmf. Cond.	40	.022 Mf. 400 V. Cond.	66B	A. C. On-Off Switch	92	Power Trans. (110-50-60)
15	680 Mmf. Cond.	41	2200 Ohm ¼ W. Res.	67	Phono Term. Board	93	Speaker (02CB Only)
16	220 Mmf. Cond.	42	2.2 Megohm ¼ W. Res.	68	Ant. Term. Board	94	100 Ohm ¼ W. Res.
17	.00274 Mf. Cond.	43	1 Megohm ¼ W. Res.	69	Socket—Sta. Selector		

PRACTICAL AUDIO AMPLIFIER THEORY

By TED POWELL

PART II

THE non-technical analysis of this simple amplifier will begin with the crystal pick-up assembly and finish off with the reproducer in order to aid the reader in maintaining an organized train of thought.

Perhaps the most important factor to consider lies in the choice of the equipment to be used. Where commercial work is concerned this of course depends upon the cost factor. In the case of a private amplifier system or where a P.A. man takes great pride in the performance of his equipment, some thought must be given to the need for quality equipment.

It is a very common blunder for amateurs, and even many professionals, to spend most of their time and thought upon circuits involved in audio systems. These are the least important, where results are concerned, because voltage amplification tubes generate but little distortion. Of course care must be exercised with phase-inversion and push-pull circuits.

The important factors in a P.A. system are the microphones, phono pick-up assembly, output transformer, and the loudspeakers used. All the wild-eyed genius-in-the-attic brainstorming in the world will not produce hi-fidelity response if bargain-counter junk is used for these components.

The pick-up must be a good unit and the more expensive it is the finer will be the results. The new low-pressure units are strongly recommended since their low-mass movements make possible a greatly extended and flattened high-frequency response, cause less needle-scratch and record-wear, and less radial and lateral slip upon the turntable.

Another blunder often made is the failure to realize the need for a high-grade turntable assembly. Poor motor torque and unsteady R.P.M. results in the familiar "wow." Gear and bearing noises generate the familiar "turntable rumble," and also the lesser-known effect of "hash," which are higher frequency components of this noise.

THE AMPLIFIER

It will be noted that pickup operates into a P/P input. This was done for two reasons. One is to eliminate the need for a single-sided input amplifier stage with its even-order harmonic and intermodulation distortion, since a low- μ Class "A" triode generates no appreciable odd-order harmonics. The distortion of an all-push-pull amplifier such as this, is limited mostly to some frequency discrimination and phase-shift distortion, if triodes are used in the output stage. If beam-power pentodes are used, additional distortion will be developed by the amplifier under maximum volume conditions.

The other reason is to eliminate the need for either a phase-inverter or a single-side-to-P/P input transformer with which to feed the P/P output stage. A transformer so far back in an amplifier will introduce altogether too much of all types of dis-

ortion, unless it is a carefully designed and very costly laboratory type of unit. A phase-inverter will also introduce some distortion, because a phase-inverter that is perfectly balanced under all signal and circuit conditions simply does not exist.

Many types of inverters have been and still are being developed, all based upon

In Part II of the series, Mr. Powell discusses the amplifier and its components. The construction of this amplifier was along the lines herein presented and its performance met the predicted expectations. Details of data pertaining to the components are also given and are worthy of study by those interested in high-quality performance.

three or four general principles, some of which are of the trick "self-balancing" types.

In the dual-tube type of inverter, where a "dummy" tube is employed, the signal fed to the "dummy" has some harmonic, intermodulation, frequency discrimination, and phase-shift distortion introduced into it by the "master" tube and the following condenser and resistor network. Perfect balance can be obtained for a limited frequency or amplitude only.

Similar criticism can be applied to other types of inverters. The defects are admittedly of a minor nature but they do exist nevertheless. When fidelity is the prime factor under consideration, it is preferable to use all P/P circuiting.

Such a circuit's superiority becomes plainly evident when an amplifier's gain is pushed up and no noticeable "cracking" of quality results. This superiority is a result of the fact that there is no appreciable even-order harmonic and intermodulation distortion present. Since low- μ Class "A" triodes generate no odd-order harmonics, this type of distortion is virtually eliminated.

To sum up, it seems well worthwhile to invest in the extra tube and in circuit components to set up the all-P/P circuiting in order to eliminate a source of distortion. Incidentally, it should be borne in mind that circuit components of both sides of each P/P stage must be carefully selected. It is sheer stupidity to set up a P/P circuit to eliminate a few percent harmonics and then go ahead and use cheap resistors and condensers varying in their values by ten or twenty percent. The unbalance resulting will more than make up for the harmonics eliminated.

TUBES USED

The reader might wonder at the motives for employing such unorthodox amplifier

tubes in this amplifier circuit. Upon checking up on the tube characteristics, he will probably wonder how such low- μ tubes could be of any use in an amplifier circuit.

To an experienced sound man, the overall gain of this amplifier will no doubt appear much too low to drive the beam-power pentodes. However, this fault is not as great as it might seem at first sight. The writer had no trouble obtaining sufficient driving signal to adequately cover small dance-halls with a version of this circuit. An elementary analysis of stage-to-stage gain made with no account taken of various circuit losses will show that nearly full driving voltage is obtained at the power grids. A crude estimate of overall gain can be made by starting with the crystal output and proceeding through the amplifier on a stage-by-stage voltage-gain basis till the power grids are reached.

PICK-UPS

The standard bending type crystal pick-up used can put out a maximum undistorted signal of about $2\frac{1}{2}$ volts across a $\frac{1}{2}$ megohm load from a standard record at 1,000 cycles. This output is split across the P/P input grid circuit and each 6AE5-GT receives a $1\frac{1}{4}$ volt signal. The gain of a 6AF5-GT is about 5 in a resistance-coupled circuit, therefore each 6AE5-GT grid gets a signal of about 6 volts. The voltage gain of the 6AE5-GT's in an impedance-coupled circuit is about 3.75. Therefore the 6L6 grids receive a signal of about 22 volts or less which is more than they require in a Class "A" circuit.

The writer used a low-plate-voltage Class "A" circuit which requires a 14-volt driving signal per grid, and also used the lower gain 6AE5-GT's in the pre-amplifier as well as in the driver stage.

Of course pick-up outputs, amplitude swings and individual circuiting conditions vary. Besides, there are losses introduced by tone-corrector, feed-back, volume control and grid and plate loading circuits. Furthermore, if the low-inertia, low-pressure, permanent jewel-stylus, hi-fidelity twister type crystal pick-up is used, or any of the new low-pressure induction, magnetic, or dynamic, type units with about $\frac{1}{4}$ volt output is employed, or if higher quality power triodes are used in the output stage, the amplifier gain must be pushed up to get sufficient driving voltage at the power grids. This gain can be obtained simply enough (at a slight sacrifice in quality) by using 6G6-G's as triodes with a V.G. of about 6.5; 6P5-G's with a V.G. of about 10; 6C5's with a V.G. of about 12; 6J5's with a V.G. of about 14; 6N7's with a V.G. of about 24; 6SC7's with a V.G. of about 42, etc.

As far as the motives for using such low-gain triodes in a phono amplifier are concerned, it might be simply said that they do have certain advantages which are not so easy to prove theoretically.

In the first place, the lower the overall

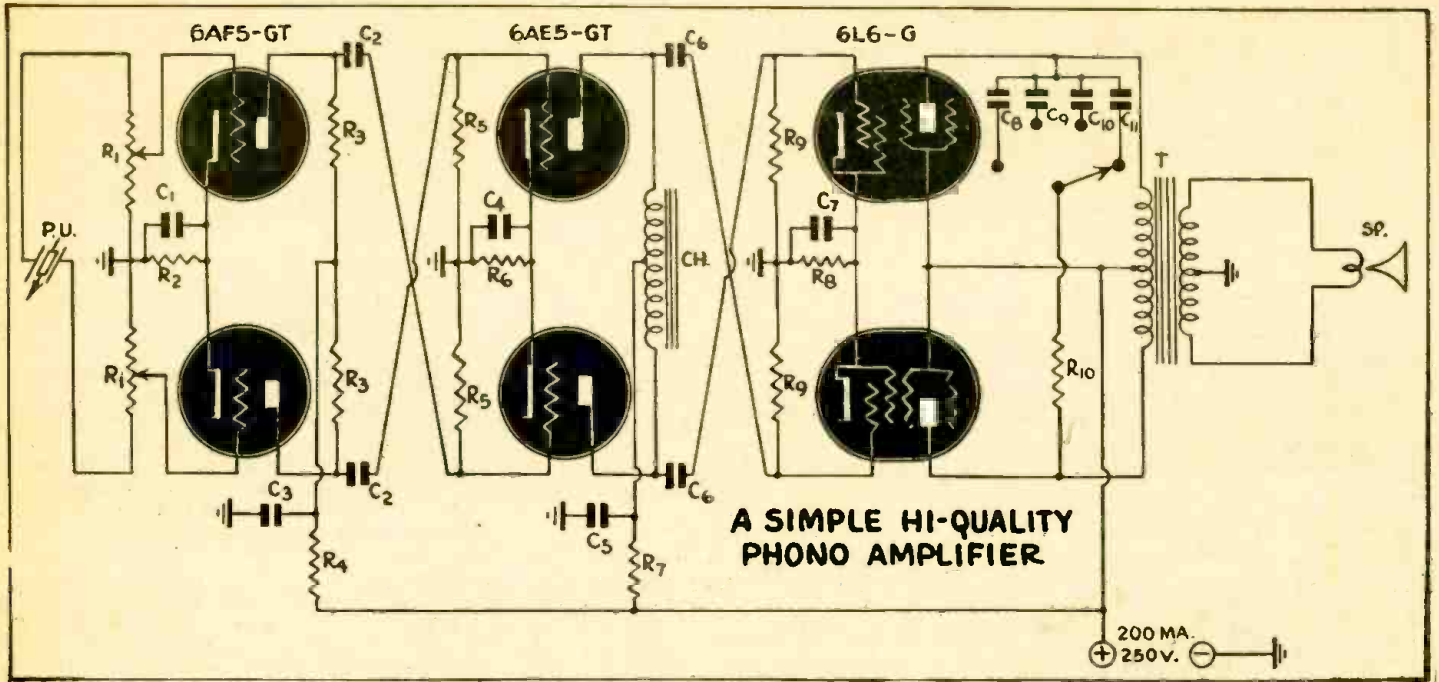

This is the diagram of the phono amplifier constructed on the principles outlined by Mr. Powell. Note the simple tone control, the use of triodes, and the unusual crossing of the grid leads. Push-pull is used throughout, to reduce to the minimum the possibility of disturbances being caused by harmonics.

gain of an audio amplifier, the lesser the probability of trouble with hum, circuit noises, microphonics, instability and distortion of various types. Furthermore, the lower the μ of an amplifier tube, the lower its plate resistance and the more effectively it can be loaded where a limited frequency range is to be handled. That is, the lower the amplifier's plate resistance, the lower the plate loading impedance has to be to get the same low-frequency response. By making possible good low-frequency response with low plate-load impedance, the "effective" plate resistance is lowered, heavier plate current flows, and better quality results. To put it in another way, if we keep increasing the plate load impedance for any given tube in order to obtain better low frequency response, we begin to get an adverse effect upon the higher frequencies because we begin to push up the gain of the middle range frequencies to a certain point where the stray shunt capacitances begin to cut off the higher frequencies rapidly. This results in an exaggerated "bend" or "knee" in the amplifier tube's characteristic, with an attendant increase in distortion caused by the steeper "cut-off" effect at the higher frequencies.

While low- μ triodes have greater inter-electrode capacitances than high- μ tubes, these effects are appreciable at frequency ranges beyond those encountered in phono recording work, i.e., 10,000 cycles for standard discs and 15,000 cycles for hi-fidelity transcriptions. Besides, small air-core chokes can be used to offset this stray capacitance cut-off effect.

Another reason for using such low-gain tubes lies in the fact that the lower the μ and the plate resistance of an amplifier, the smaller becomes the margin of fidelity superiority of resistance coupling over impedance coupling.

A final though rather petty reason for using the low-gain tubes, is the fact that with lower overall gain, less use of the volume control is necessary. Theoretically, such a potentiometer is more or less self-compensating in its effects upon an audio circuit, in that the series leg chokes off the higher frequencies as rapidly as the shunt section shorts out the lower ranges. How-

ever, there seems to be some adverse effects noticeable in practice, probably slight phase-shift and frequency discrimination distortion, especially when the volume control must be cut in heavily. With a low-gain amplifier circuit designed especially for phono work, the volume control is used at near its maximum setting, and its slightly detrimental effects are minimized. No doubt more elaborate types of controls, called pads, would tend to eliminate this defect.

LOW-MU TRIODES

Incidentally, it is rather odd to note the almost total absence of the low- μ triodes in audio work. While high gain is an economy necessity, the use of a separate channel for the phono circuit is not unreasonable in the case of a high-class system. They should especially have some real possibilities as phase-inverters in hi-fidelity work where, with their lower gain, better balanced inversion circuits should be possible.

Some readers might inquire that if overall gain is the theme here, why are two amplifier stages employed? Why not use a single hi- μ triode or pentode stage to drive the 6L6's and thus lower the total distortion developed, simplify circuiting, save space and lower costs?

It must be remembered that such a driver would require resistance loading. The high-impedance choke that would be required for such high resistance plates would have much too much winding, and too much stray shunt capacity, to make possible high fidelity. Therefore, resistance-loading would be necessary in order to achieve passable frequency response and gain.

This means a high "effective" plate-resistance and low plate-current and therefore inadequate plate power with which to really push the power tubes with their relatively high input admittances (slight grid currents and high inter-electrode capacitances, etc.). Of course, the technical aspects here are more involved and a simple word-picture such as this is wholly inadequate. At any rate, the use of low plate-current hi- μ tubes as drivers is not wholly satisfactory and their use here will usually result in a harsh and tinny quality.

While hi- μ pentodes with their smaller

inter-electrode capacitances will possess a vastly more extended high frequency range than triodes, their advantage in this respect is pointless in the case of a phono amplifier since the frequency range is greatly limited. Besides, the extended frequency-range is marred by the odd-order harmonic and intermodulation products generated.

LOW GAIN USED

As a result, it will be found that a two-stage low-gain circuit will produce superior over-all response than that obtained from a single high-gain stage, at least as far as listening tests are concerned.

The capacity values of the coupling condensers might seem rather high. They were made so in order to take full advantage of the amplifier's inherent stability and thus insure good low frequency response.

The coupling condensers between the 6AF5-GT's and 6AE5-GT's could be reduced to 0.05 mfd. and the response would probably be flat, down to 25 cycles and flat to within a fraction of a DB down to 10 cycles. In commercial amplifiers this value could be lowered still further without appreciable effect upon performance. However, 0.1 mfd. units produce what amounts to direct coupling for all practical purposes. That is, if we ignore slight capacitive reactance phase-shift and cut-off effects at the lowest frequencies and slight inductive and minor dielectric effects at the higher frequencies.

DISTORTION

Higher values of coupling capacity should not be used because it will be found that a distortion effect takes place at the higher frequencies. This was at first supposed by the writer to have been due to the greater leakage of the larger condensers. However, it was later noted that the same trouble was evident when condensers of the same rating but of higher voltage were substituted in a coupling circuit. The conclusion is fairly obvious. The effect was plainly due to the greater volume of dielectric present and not to greater leakage. Therefore some sort of dielectric hysteresis must be the culprit.

Radio literature seems to make no recog-
(Continued on following page)

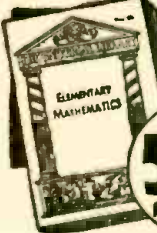

**The Book that Takes
Drudgery out of
Mathematics**

Only **50c** postpaid

SOLVES EVERYDAY PROBLEMS — HELPS YOU GET AHEAD IN LIFE

How many times have you lost money because of a mistake in figuring? Do you know how to figure quickly and correctly? Can you figure discounts, interest rates, taxes and all the other calculations you meet up with in your daily life?

Are you having trouble qualifying for Army or Navy promotion because you're not up on mathematics?

Here is the book that gives you a good background in mathematics; that takes all the irritation and drudgery out of it. You don't need to be scared of mathematics, because here's the subject explained without frills, without useless computations.

Here's the book for men in the armed forces; for business men; technicians and craftsmen, explaining and answering everyday mathematical problems in easy-to-understand words and illustrations.

Yes, it's the key to a simple understanding of mathematics. It's a real home-study course in mathematics for the man who's alert to the importance of mathematics in the world today.

ELEMENTARY MATHEMATICS

• EASY — SIMPLIFIED — PRACTICAL •

CONTENTS OF BOOK

CHAPTER I. Arithmetic—Addition—Subtraction—Multiplication—Division.

CHAPTER II. Factoring and Cancellation—Fractions—Decimals—Percentage—Ratio and Proportion.

CHAPTER III. The Metric System.

CHAPTER IV. How to Measure Surfaces and Capacity (Geometry).

CHAPTER V. Powers and Involvement—Roots and Evolution.

CHAPTER VI. Mathematics for the Manual and Technical Craftsman—Thermometer conversions—Graphs or Curve Plotting—Logarithms—Use of the Slide Rule.

CHAPTER VII. Special Mathematics for the Radio Technician.

CHAPTER VIII. Commercial Calculations—Interest—Discounts—Short Cut Arithmetic.

CHAPTER IX. Weights and Measures—Useful Tables.

ONLY **50c** POSTPAID

Send Stamps, Cash or Money Order.

Send today for your copy of this indispensable book. It can be carried readily in your pocket. (Size 6 1/2 x 9 in.)

TECHNIFAX

1917 S. State St., RC-343, Chicago, Ill.

SPRAYBERRY RADIO TRAINING

includes

FULL EQUIPMENT

Experience Easily Acquired at Home



You Do Practice—Giving Experiments. Many Special Features. ALL Designed to Help You Make Fast Progress

SPRAYBERRY

Training starts right at the beginning of Radio. It unfolds each subject in a simplified, logical, understandable style. You easily learn Television, Frequency Modulation, Signal Tracing, Mobile Radio (Auto-Tank), Aviation Radio, Electronics, Facsimile Radio, Radio Set Repair and Installation Work.



Training Prepares You for a Business of Your Own or Good Radio Jobs—Civilian or Military

The important and fascinating field of Radio offers many opportunities to the man who wants to get ahead. My Training will help you win quick promotion in the Army or Navy. It will fit you for a bright Civilian career. SPRAYBERRY Methods are thorough and practical. Your Training will not interfere with your present duties. No previous experience is needed.

You Get a Dual-Purpose Radio Set

I supply you with Radio Parts which you use to gain pre-experience in Repair work. These same Parts are used as a Modern Signal Generator and for Signal Tracing, etc. You'll find my Course and Equipment fully described in the catalog offered below.

Earn While You Learn

My BUSINESS BUILDERS show you how to put your equipment to actual use in handling money-making Radio Service Jobs shortly after you begin Training.

THE SPRAYBERRY COURSE IS SOLD UNDER MONEY-BACK AGREEMENT



RUSH COUPON for BIG FREE BOOK

SPRAYBERRY ACADEMY OF RADIO
F. L. Sprayberry, President
620-C University Place, N. W.
Washington, D. C.

Please rush my FREE COPY of "HOW TO MAKE MONEY IN RADIO."

Name Age

Address

City State

(Mail in envelope or paste on penny postcard)

PRACTICAL AUDIO AMPLIFIER THEORY

(Continued from previous page)

tion or analysis of this phenomenon, if it really does exist. A possible source of audio distortion in transmission lines, transformers and condensers might be traced in this way. The use of plastic or spun-glass insulation, oils, vacuum canning of windings, more generous use of coaxials, etc., might be advisable in hi-fidelity audio systems. Thus we might conclude that tubulars with voltage ratings barely adequate for the potentials existing in the circuits into which they are to be inserted should be preferable. This would tend to lower the dielectric sources of audio distortion at the higher frequencies.

DIELECTRIC HYSTERESIS

Dielectric hysteresis is a power loss similar to magnetic hysteresis in that the molecular inertia effects of the insulation material prevent the molecular electrostatic fields from reversing in phase with the electrostatic field generated by the currents surging in and out of the condenser. In other words, the dielectric molecules have a time-lag in attempting to reverse in synchronism with the complex audio frequency E.M.F.'s impressed across the condenser terminals. Since the hysteresis-vs.-frequency characteristic is not ordinarily strictly linear, and since the currents flowing into audio circuits are highly complex, some detrimental effects must take place which cause some wave-form distortion. There may be another minor effect similar to magnetic "lag" or magnetic "viscosity."

Dielectric hysteresis makes itself evident as a heat loss much the same as in the case of most other types of losses and is the principle factor in determining the rating of a condenser or any other insulated circuit where copper and iron losses are negligible or non-existent. Excessive dielectric losses result in overheating, dielectric ionization, deterioration and eventual breakdown. That is why condensers have a voltage or breakdown voltage rating as well as a working voltage rating.

Incidentally, in power engineering work, it is a well known fact that "leading" power factor networks tend to exaggerate harmonics existing in a fundamental frequency working through it, and "lagging" power factor circuits tend to suppress them. This is easy to demonstrate mathematically, but to put it simply, since a condenser's reactance decreases with increase of frequency, it will tend to exaggerate harmonics existing in a fundamental frequency operating through it since the harmonics are of a higher frequency.

At any rate, for various reasons mentioned above, the value of the amplifier-to-driver coupling-condensers was held to 0.1 mfd., and that of the driver-to-power-grids condensers was fixed at 0.5 mfd., even though theory would call for larger values in order to get more extended low-frequency response.

If the amplifier should show signs of having a "boomy" quality, or mild oscillation effects, or excessive turntable rumble for any given set of amplifier system and acoustic conditions, the values of the coupling and loading resistors can be lowered somewhat till the trouble clears up.

COMPENSATING CHOKES

This, of course, is accomplished by lowering the low-frequency response. The small air-core compensating-chokes in series with the plate load resistors in the first amplifier stage may be rather superfluous in view of the fact that the frequency range to be handled is rather limited. It so happened

that some television video amplifier units were lying about and they were used.

Such chokes are often used because simple resistance loading of amplifier plates does not produce the ideal linear loading that is desired, because of the stray circuit and tube inter-electrode capacitances which by-pass and cut-off the higher frequencies. By inserting small air-core chokes of the proper values in the plate loading circuits, the small stray capacitances are tuned or resonated so that unity power factor or pure resistance loading is achieved at the higher frequencies. Thus high frequency response is flattened and extended out to a certain limit where at very high frequencies the stray capacitances again take control and a rapid cut-off takes place. If the choke inductance is too great, an undesirable peak will be present within the frequency range being handled, and if too small, only a partial correction will take place at the higher end of the response curve.

OSCILLOSCOPE CHECKS

Sine-wave oscillator and cathode-ray oscilloscope checks can be made to determine the optimum values of such compensating chokes for any given circuit. However, multivibrator (square-wave) generator checks are much more efficient, and much more rapid than those possible with sine-wave generators. While sine-wave checks make possible the running off of response curves and quantitative checks of simple harmonic and frequency discrimination distortion, it should be remembered that such a check holds good for a simple sine-wave signal only. Modern technicians now disregard simple harmonic distortion ratings as worthless and gauge the performance of audio systems by much more dependable standards as will be explained later.

Square-wave checks permit rapid comparative visual check-ups of circuit performance by simply sending square-wave signals of various frequencies through the circuit to be tested and watching the shape of the square-wave as it passes through. In the case of the compensating chokes, as turns are added or removed, the shape of the square wave is watched, and when it is the "squares" the optimum value of choke impedance has been obtained. The generator frequency should be set near the high end of the frequency range that is to be handled by the audio system.

Obviously, the exact value of such a compensating-choke will vary with each amplifier since stray circuit constants vary somewhat. Generally speaking, the values of such chokes will lie at about a 500-microhenry range, the exact value depending upon the tube and the circuit constants involved. Plate and grid loading resistors may be altered somewhat to further improve response.

There are other and more involved compensating circuits in use in audio and video amplifiers. One of them, the low-frequency compensating-circuit type, simply consists of the proper combination of isolating resistor and condenser in the plate circuit, grid, plate load, and cathode resistors and by-pass condensers, such that a phase-shift and cut-off correction effect takes place.

Another consists of a heavy condenser in series with a high resistance shunted across the coupling condenser.

There are some rather elaborate series-shunt correction circuits in use for obtaining compensation at high frequencies, described and analyzed in literature on television video amplifiers, notably in the "RCA Review" and the "Proceedings of the I.R.E."

(Continued on page 379)

**"HOGARTH IS REALLY HIGH
ON HIS *ECHOPHONE EC-1*"**

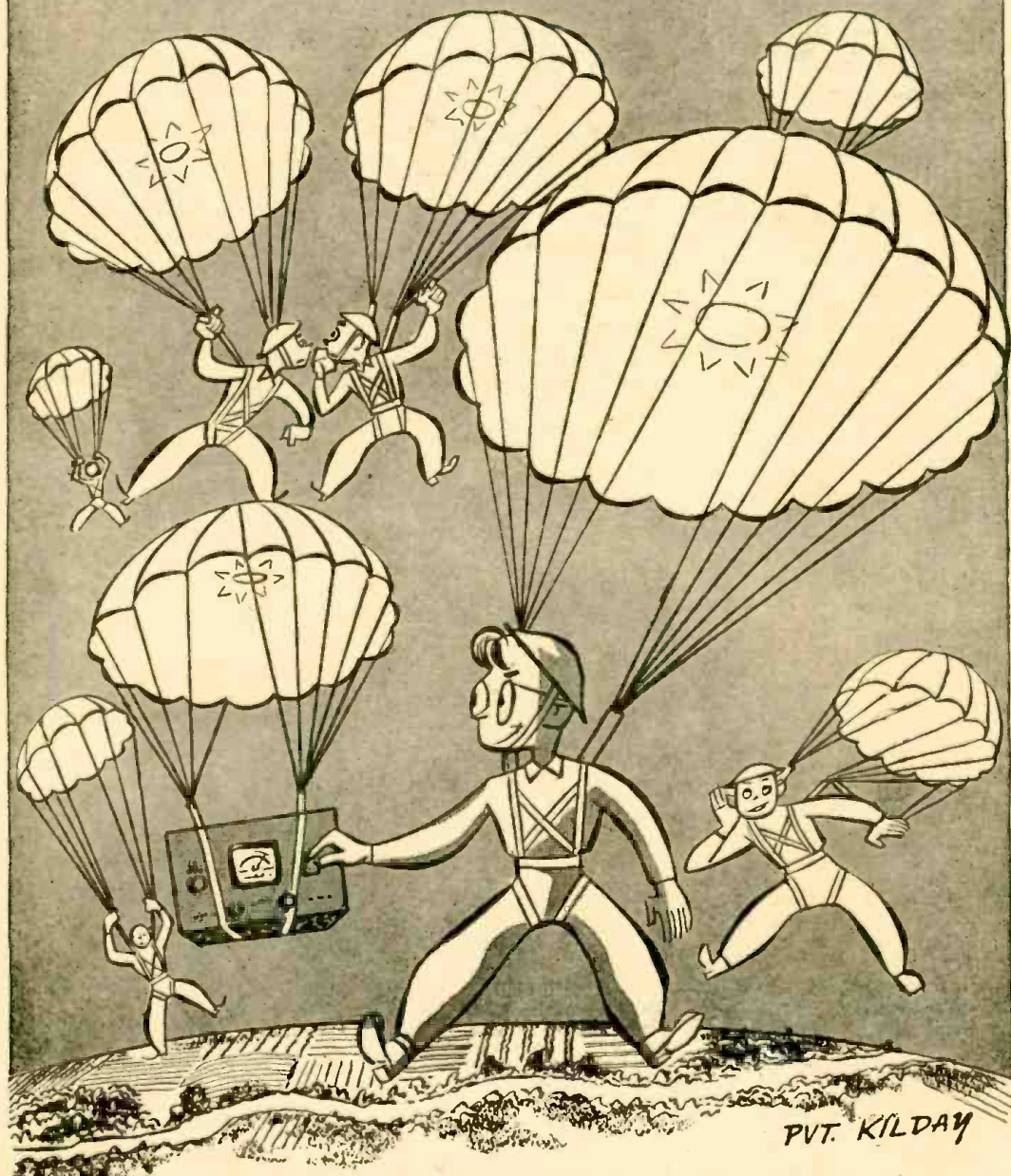

PVT. KILDAY

Echophone Model EC-1 6 tubes, 3 bands. Tunes from 550 kc. to 30 mc. Beat frequency oscillator. Bandsread logging scale. Self-contained speaker. Electrical bandsread on all bands. AC/DC, 115-125 volts. ECHOPHONE RADIO CO., 201 EAST 26TH ST., CHICAGO, ILLINOIS

HOW SUPERHETS WORK

THE heterodyne receiver, called colloquially the "superhet," is not a recent development and in fact dates back to the beginning of the century so far as the fundamental principles are concerned. The first practical superhets were a product of the last war when the need arose for greater amplification of the radio frequencies and the tubes available were limited in performance compared with present-day products.

The amplification of radio frequencies has always been a problem, and the higher the frequency the more difficult the problem becomes. The stray capacities in the wiring and the tube capacities are effectively in

The "beats" would still convey the modulation forming the speech or music, and could be rectified, after amplification, in the usual way. This is the principle on which the superheterodyne is designed, and its operation can be understood by following a signal through the various stages as given in the diagrams.

BEATS

The phenomenon known as "beating" occurs whenever two oscillations which are fairly close together in frequency combine to produce an output. The effect is shown in Fig. 1, and can be studied by drawing a series of waves differing slightly in frequency and adding them together graphically. The resulting wave will be seen to consist of a series of high and low amplitude peaks, the maximum amplitude occurring when the combining waves are "in step" and the minimum when they are "out of step." ("phase" would be a more scientific term).

If the original frequencies were audible, say C and C sharp, the combined wave would be audible as a series of throbs or beats, each beat corresponding to a rise in amplitude of the resulting wave. Those who have access to a piano which can be tampered with, can try the effect of slightly detuning one of the two strings which form each note in the base register. On striking the key, the beat between the two frequencies will be heard clearly, its frequency depending on the difference between the frequencies of the two strings. Lower C is approximately 128 cycles per sec., and if the second string of the pair is detuned to vibrate at 120 cycles per second, a beat note having a frequency of (128-120) or 8 cycles per second, can be heard and counted.

The effect is exactly the same whether the frequency of the note is raised, or if two oscillatory circuits are used. Suppose one is oscillating at 128,000 cycles per second (increasing the original figures a thousandfold), and the other at 120,000. The beat frequency will then be 8,000 cycles, which will be audible, as a whistle. Increase the frequencies another tenfold and the resultant beat note will then be 80,000 cycles, which will be inaudible, since it is above the range of the human ear.

Frequencies above audibility are termed "supersonic." We are now getting into the working region of the superhet, a frequency of 1,280 kilocycles per second corresponds to a frequency in the broadcast band, and if it is combined with a wave generated by a local oscillator at 1,200 kc., the resultant beat frequency is 80 kc., which is easier to amplify than the original 1,280 kc. signal.

The incoming frequency, in the case of a radio receiver, is modulated at audio frequency and instead of being the continuous oscillation of Fig. 1, will be more like the upper curve of Fig. 2. The fluctuations in amplitude produced by the audio-frequency modulation appear in the beat waveform, which should be compared with that of Fig. 1.

DETECTION

In combining the incoming signal with a locally-generated signal we have not lost the modulation, which is, of course, a most important point.

If the modulated beat frequency is passed

through a detector in the usual way the plate current of the detector will follow the average height of the complex wave of Fig. 2, and will be of the form of Fig. 3—top. Note that the plate current fluctuation follows two influences: the main fluctuation frequency of the beat, and the current rising with each pulse of increased amplitude and falling with the troughs of the waves.

At the same time the general level of the plate current peaks follows the wave-form of the modulating frequency. The fluctuation due to the beats is seen more clearly in the lower diagram of Fig. 3 which has had the high frequency component taken away. This wave is then amplified by successive stages of tuned circuit and tubes, until it is of sufficient amplitude to be rectified a second time, leaving the audio frequency component only.

The diagram of Fig. 4 shows the beat frequency modulated by the signal, and its rectification to produce the final audio-frequency wave which is of the same form as the original modulation.

A superhet, therefore, requires two detector stages—the first immediately following the local oscillator, which rectifies the modulated beat frequency (ofttimes accomplished in a "mixer" such as the NA7), and the second (such as the 6SQ7), which removes the beat frequency to leave the original modulating frequency.

Instead of the term "beat frequency" we can use the more common one, "intermediate frequency," abbreviated to "I.F.," to denote the frequency difference between the original radio frequency and the audio frequency produced after detection for the second time.

The most important difference between the performance of the superhet and that of an ordinary tuned-circuit radio-frequency amplifier is, that in the superhet all the amplification is done at a fixed frequency, that of the beat, while in a "straight" R.F. amplifier all the circuits must be tuned to the frequency of the incoming signal.

Once the tuned circuits of the superhet have been adjusted they need no alteration, and this makes for a neat and reliable form of construction of the amplifying stages.

It is also possible to design the I.F. tuned

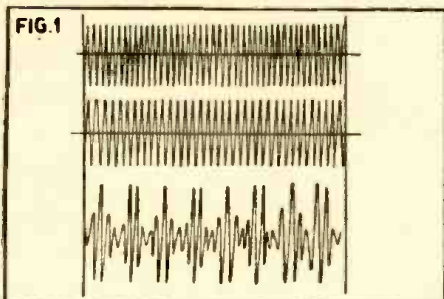

Fig. 1—Shows how two notes of slightly different frequency combine to produce "beats."

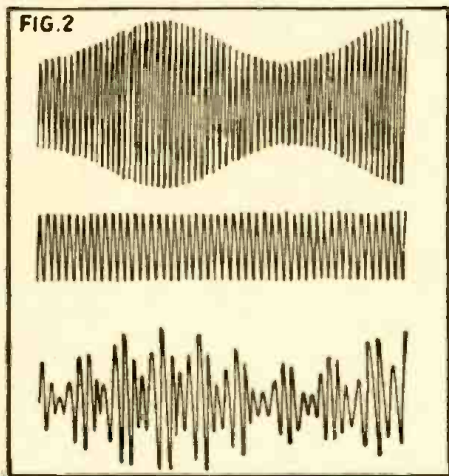

Fig. 2—Shows how a modulated carrier wave, combined with a local oscillation frequency, reproduces the modulation in the beat frequency.

parallel with the output of an R.F. amplifier stage and their low impedance to high-frequency reduces the gain of the stage considerably. In some television-frequency circuits the gain per stage with the best of the modern tubes is less than 5, so the difficulty of amplification with the cruder tubes of 1917-1918 can be imagined.

EARLY INVESTIGATIONS

The development of the superheterodyne method of reception was due to the attempts to overcome the difficulties of high-frequency amplification, and the obvious line of attack was to reduce the frequency as much as possible to overcome the shunting effect of the circuit capacities. It occurred to Armstrong in America, and, independently, to Schottky in Europe, that if the radio frequency from the aerial could be combined with a locally generated oscillation which differed slightly in frequency, the resultant "beats" could be amplified more easily than the original signal.

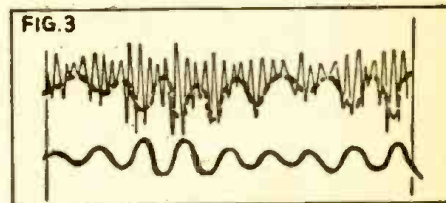

Fig. 3—The modulated beat frequency, after rectification, showing the plate current fluctuations following the modulation.

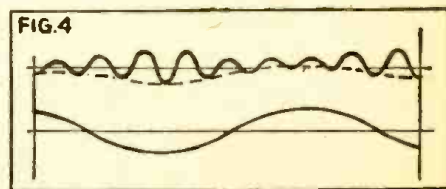

Fig. 4—The modulated beat frequency after detection a second time, leaving the audio frequency component.

circuits for maximum efficiency at the frequency chosen, whereas it is impossible to obtain maximum efficiency from tuned circuits over a wide range of frequencies, without some adjustment.

SELECTIVITY

One of the difficulties of present-day reception is to keep unwanted stations from interfering with the one to which the receiver is tuned. The higher the frequency to which a circuit is tuned, the more difficult it is to keep out unwanted frequencies, because the percentage difference between the two may be very small.

As an example, if a circuit is tuned to 1200 kc., a frequency of 1250 kc. will be passed, as the percentage difference is only 5 in 120, or about 4 per cent. Now suppose that the frequency of 1200 kc. is combined with an oscillation at 1656 kc., to produce an I.F. of 80 kc. The unwanted signal will produce a beat frequency of (200-125) or 75 kc., and the difference between this and the I.F. of 80 kc. is 5 in 80 or nearly 7 per cent. These figures are taken at random and the actual results obtained show much wider differences.

It should be noted that there are two incoming signals which will produce the same beat frequency with a local oscillator. If the oscillator frequency is 450 kc., a signal of 500 kc. will give a beat frequency of 50, but so will a signal of 400 kc. This effect produced by a second unwanted frequency is known as *second channel interference*, and can be very troublesome, if the local oscillator frequency is chosen so that there are two stations beating with it at the same time.

The frequency of the local oscillator is always chosen with regard to the frequencies in the broadcast band and is not taken at random. It has been found that the most satisfactory frequencies are around 450 kc., and most superhets use one frequency or another in this region. The selectivity of the tuned circuits can then be designed so that there is minimum interference from adjacent frequencies in the band.

SUPERHET CIRCUITS

The circuit of the superhet may be said to be built round the oscillator, as the performance of the receiver depends on the constancy of the oscillator frequency. If this alters, the I.F. alters and the tuned circuits of the I.F. amplifier are thrown out.

FREQUENCY CHANGING

In the early superhets the local oscillations were produced by a separate tube, which was inductively coupled to the detector circuit, but later developments simplified the circuit and tubes were designed to combine the functions of oscillator and detector. Separate oscillators are still used, however, in television and in some short-wave receivers.

The incoming signal is usually passed through one stage of radio-frequency amplification, before being "mixed" with the local oscillation. The tube performing this is often referred to as the "mixer tube."

TYPES OF MIXERS

A simple mixer circuit is shown in the diagram of Fig. 5 in which a screen grid (or tetrode) tube combines the function of detector and oscillator.

The incoming radio signal is applied to the grid in the usual way and the tube is biased by a resistance in the cathode circuit to act as a "plate-circuit" detector. An oscillatory circuit is connected between plate (in some multi-grid tubes called the No. 2

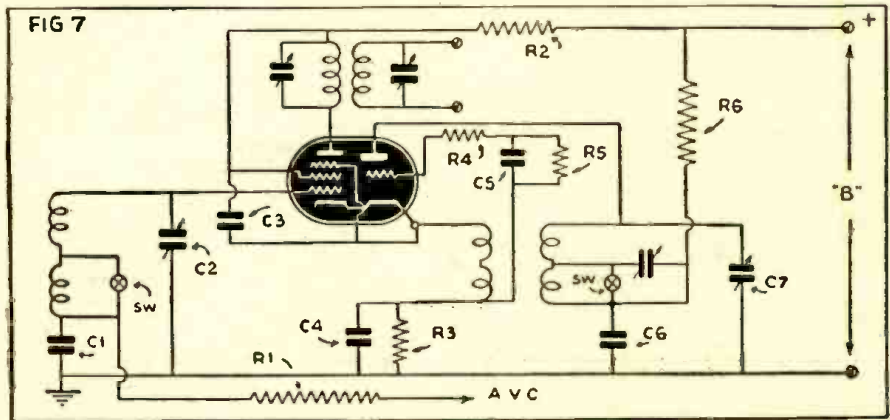
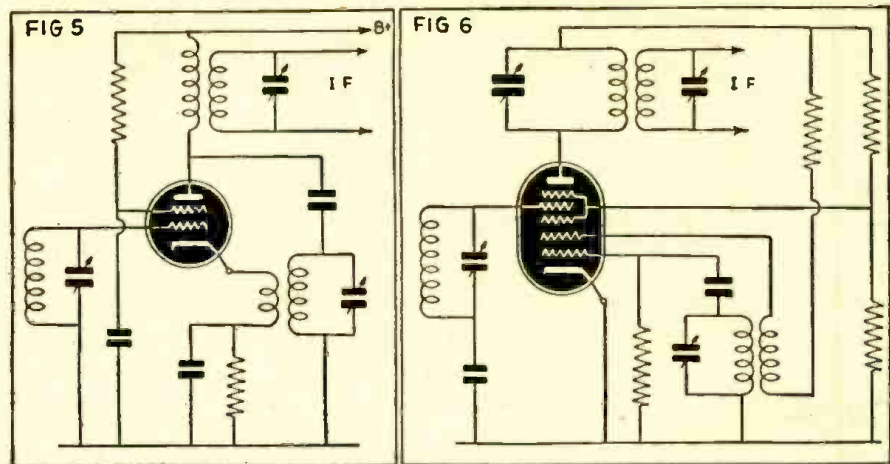

Fig. 5—A simple circuit for injecting an oscillation into the first detector. Fig. 6—A tube used as a combined oscillator and detector. Fig. 7—A pentode tube in which the coupling is by electron stream.

grid, or the "anode-grid"), and cathode, and coupled back to the grid through the coil in the cathode circuit. The anode circuit thus contains three frequencies—the radio signal, and the sum and difference of the oscillator and radio frequencies.

The difference of the frequencies is the one required, and this is obtained by coupling a tuned-circuit to the anode coil as shown. This is the "I.F." transformer, and it feeds the I.F. to the next tube.

Some receivers use a separate tube for the oscillator, but most of them use a pentagrid mixer type.

In some of the older receivers, many of which are still in use, coupling of oscillator to first detector, or mixer, was accomplished through cathode coupling, as shown in Fig. 5.

A more complicated form of combined oscillator and detector which is widely used is the one shown in Fig. 6. The tube has seven electrodes, and is therefore a *heptode*, and the coupling between the oscillator portion and the detector is in the electron stream itself. It is as though the oscillations modulated the detector current flowing to the plate. This form of mixing is very efficient and stable owing to the absence of stray coupling between components outside the tube. The 6A7 is representative of this type of tube.

Note that the signal is *not* applied to the first grid (the one nearest the cathode), but that the first and second grids form an oscillatory circuit in which the second grid acts as an anode. The electrons pass through this "anode," and are controlled by the *fourth* grid to which the input signal is applied. The *fifth* grid acts as the screen in an analogous way to that in a tetrode, while the output is taken from the plate circuit in the usual way. Electrons from the cathode are thus modulated twice on their

way to the plate—first by the oscillatory circuit, and then by the radio input.

Another variation of the "one-man-band" type of tube is the triode pentode, shown in Fig. 7, in which the pentode portion has an extra grid added which is directly connected to the oscillator grid. The principle of most of these multi-electrode mixers is the same—combined modulation of the electron stream and a further diagram is unnecessary here.

SUMMARY

The superheterodyne principle is used in radio receivers chiefly because it provides the maximum in sensitivity and selectivity with the minimum of tubes.

The sensitivity is enhanced through the use of the local receiver oscillator, and the selectivity is intensified with the R.F. pre-selector circuit before the mixer, and through the single-channel I.F. stages succeeding.

Also detection is simplified through the use of the diode type detector, which can handle large signals with minimum distortion. This detector followed by a high- μ triode stage and a single tube in the power stage enables a very simple superheterodyne receiver to be produced.

It might interest the reader to know that the developments in tubes, and the improvements in tuning coil and condenser design and construction have all taken place over a period of about twenty years, and that research on the subject will probably continue.

Superheterodyne principles and circuits cover a vast field and their applications can be of tremendous interest to the experimenter, the set constructor and the amateur.—Courtesy *Electronics and Television & Short Wave World*, London.

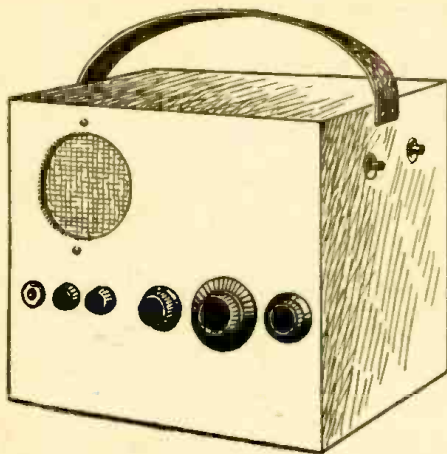

The battery superhet mounted in its portable carrying case, which can be home-made or purchased.

SIMPLE SUPERHET FOR BEGINNERS

By HARRY BERGQUIST

For those beginners who have done quite a bit of set-building and experimenting, this simple battery-operated superhet for reception on the short-wave and broadcast bands, should not prove difficult. A set like this is always handy to have around.

WISHING to have a short-wave receiver that would do for portable use as well as fixed-station foreign broadcast listening, I decided to see what could be done with some old parts and some old battery-operated tubes.

The final result was gratifying, as foreign stations rolled in with ample volume on the loudspeaker. These were brought in on an "L"-type antenna. By using a short piece of curtain rod clipped to the grid cap of the 1A7GT the "local" foreigners came in with loudspeaker volume.

The circuit is the conventional superheterodyne employing A.V.C. action. I decided on using plug-in coils, and to have individual tuning of the oscillator and antenna sections.

The I.F. transformers are of the standard air-core variety, double-tuned.

The impedance transformer is made by hooking the primary and secondary of a 3:1 audio frequency transformer in series.

Condensers C1 are 140-mmfd. These were found on an old short-wave regenerative set.

Condensers C2 consist of some old T.R.F. condensers that were cut down to three plates each and used for band-spreading.

I used this method rather than the ver-

nier dial, since the tuning condensers are mounted below the chassis.

The main thing to consider is careful

wiring and the running of short R.F. leads. It is better to bring all "ground" leads of the R.F. section to a common ground, and

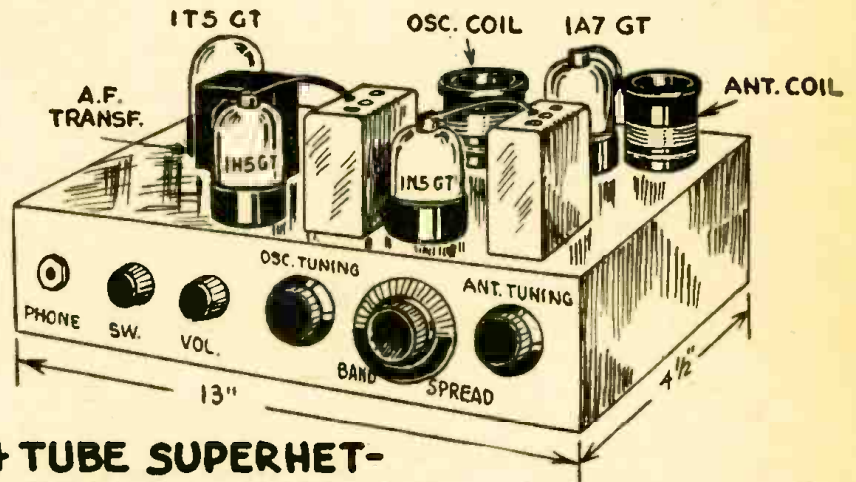

4 TUBE SUPERHET-SHORT-WAVE RECEIVER;

{ BAT. OPERATED WITH PLUG IN COILS }

Views of the chassis with tubes, coils and knobs all mounted. Note the neat arrangement.

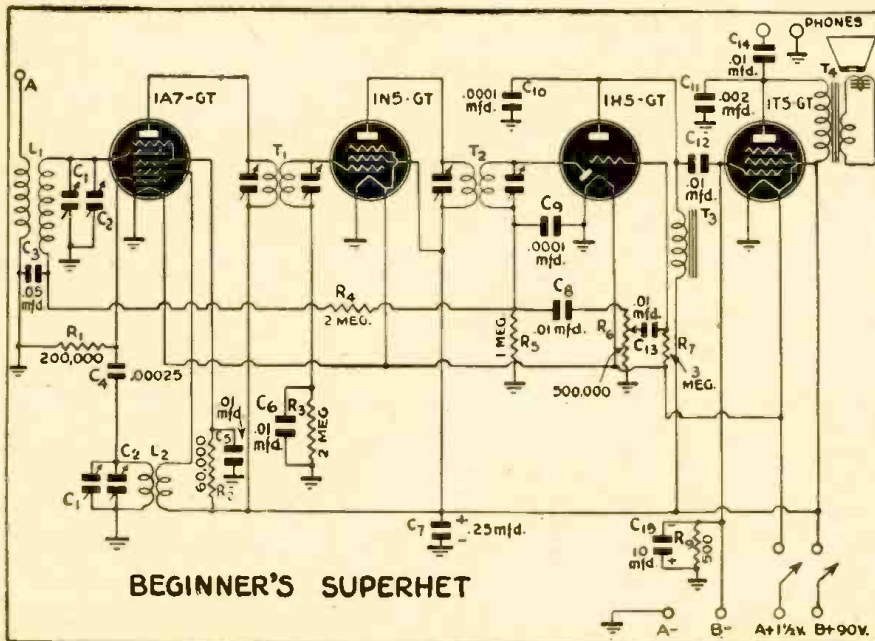

Circuit diagram of the simple battery superhet. A diagram such as this is often easier to follow than one using alternating-current type tubes.

soldered to the chassis at one point. The loudspeaker may be mounted next to the 1H5GT tube, and the chassis placed in a wooden cabinet.

Space may be left below the chassis for the battery compartment.

COIL DATA

The 19-meter coil is wound on a No. 30-type tube base. The grid coils of each are wound with 5 turns of No. 20 wire, spaced the depth of the wire. The antenna plate coils consist of four turns of No. 30 wire, close-wound.

The 31-meter coils are wound on 4-prong 1 1/4-inch diameter tube bases. The grid of the oscillator coil is space-wound with 13 turns of No. 30 wire. The plate coil consists of 6 turns of No. 30 wire, close-wound. The grid of the antenna coil is space-wound with 14 turns of No. 30 wire. The antenna coil consists of 6 turns of No. 30 wire, close-wound.

The 49-meter coils are wound on 4-prong 1 1/4-inch diameter tube bases. The grid of the oscillator coil is 20 turns of No. 30 wire, close-wound. The plate coil is 8 turns of No. 30 wire close-wound. The grid of the antenna coil is 24 turns of No. 30 wire close-

(Continued on following page)

wound, and the antenna coil is 5 turns of No. 30 wire close-wound.

Parts List

CONDENSERS

- C1—0.00014-mfd. tuning condensers
- C2—0.00015-mfd. tuning condensers
- C3—0.05 mfd. 200 volt
- C4—0.00025 mfd. mica condenser
- C5—0.01 mfd. 200 volt
- C6—0.01 mfd. 200 volt
- C7—0.25 mfd. electrolytic condenser
- C8—0.01 mfd. 200 volt
- C9—0.0001 mfd. mica condenser
- C10—0.0001 mfd. mica condenser
- C11—0.002 mfd., 200 volt
- C12—0.01 mfd., 200 volt
- C13—0.01 mfd., 200 volt
- C14—0.01 mfd., 200 volt
- C15—10 mfd., 25-volt, electrolytic condenser

RESISTORS

- R1—200,000-ohm, 1/2-watt
- R2—60,000-ohm, 1/2-watt
- R3—2 megohm, 1/2-watt
- R4—2 megohm, 1/2-watt
- R5—1 megohm, 1/2-watt
- R6—500,000-ohm potentiometer
- R7—3-megohm, 1/2-watt
- R8—2-megohm, 1/2-watt
- R9—500-ohm, 1/2-watt

- 1—1A7GT tube
- 1—1N5GT tube
- 1—1H5GT tube
- 1—1T5GT tube

- 4—Octal sockets
- 2—Four prong sockets

- 2—I.F. transformers 456

- 1—A.F. transformer 3-1
- Knobs, jack, pin jacks, speaker, phones, wire, solder, chassis, panel, grid caps and lugs.

THE TUBE SITUATION

"WHAT'S the story on radio tubes—I've got sets on my floor all repaired and ready for delivery, except that I can't deliver because they require such and such tubes—I don't have any, my regular jobber doesn't have them, I've tried elsewhere with the same answer—Don't you realize that I'm being forced out of business—I can't even find substitute types—What am I going to do—Why doesn't Washington do something—etc." So runs the theme of letters being received daily from the trade by all the tube manufacturers.

Servicemen are entitled to know the true situation and what is being done. First of all, let us make this clear—we are fully cognizant of the tube shortage which exists on a number of types and foresaw this many months ago. Also, we know that the Radio Branch of the WPB, particularly the Civilian Radio Section, is completely aware of the condition, partly as a result of our efforts and the cooperation of the National Radio Parts Distributors' association.

We firmly believe that everyone who has to do with the radio tube industry, including the WPB, the OWI, and the military authorities, now recognizes that radio sets should be kept in operation and that replacement parts and tubes are a necessary civilian requirement, second only to military needs.

At the outbreak of hostilities, we announced our policy which is aptly expressed by our slogan—"VICTORY IS OUR BUSINESS." What the Government needs and asks of us is what we must deliver. The manner in which we have "delivered" is typified by the Army-Navy "E" Flag which we proudly fly. On the other hand, if we can do the job for the military which is needed and expected of us and still manufacture a reasonable quality of tubes for essential civilian requirements, we want to do it and you can depend on us to provide as many civilian tubes as conditions will permit.

There are many difficult problems involved too numerous to mention, such as material shortages, labor and machine capacity. But again, if we can find the way, without detracting from our war effort, we

Meissner Intercommunications Kit Chassis (Assembled)

FOR INTERCOMMUNICATIONS CLASSROOM TRAINING...

... Use a Meissner Kit! ... Complete, No Parts to Buy!

To meet the increasing demand for defense Classroom Training in Intercommunications, Meissner Engineers have designed an Intercommunications unit in Kit form. The Kit is complete, including all necessary parts, tubes and cabinet. Designed to cover a wide variety of requirements, the Master unit will communicate with 11 stations—regardless of type, Master or Substations mixed in any proportion and in any order. If all are Master Stations, the maximum number of stations possible on the system is 12.

Each Master Station is supplied with a special 13-wire 5-ft. flexible cable complete with connectors. The Intercommunications Kit, when completed, occupies a minimum of space. The Station indicator plate on the Master unit is designed to permit frequent changes in markings without damaging the surface. Each Kit contains unusually complete instructions, including data on construction of a junction box.

Model No. 10-1182
Meissner Master Station Kits, including all parts, tubes, cabinet, etc. School Net Price . . . \$18.90

Model No. 10-1183
Meissner Substation Kit includes cabinet, speaker, switch, and all mounting hardware, etc. School Net Price . . . \$6.75

See your Meissner distributor or write

MT. CARMEL, ILLINOIS

"PRECISION-BUILT PRODUCTS"

will continue to do our best. Customers, who are familiar with the general situation will agree that in spite of the many problems and the increased demand, we have done surprisingly well in supplying replacement tubes.

Most of you know, that, under priority regulations in effect since October 3, 1942, we have not been permitted to deliver radio tubes except on a priority rating of A-3 or higher. Jobbers are limited in the amount of inventory that they may carry and the tubes and types they may order. To obtain tubes for civilian use, they must file applications with the WPB for preference ratings before they can place orders with manufacturers. At first this caused some little confusion and delay; however, at the present time the system is working out very well.

The WPB Radio Division has, for some time, been working on a program to provide for the manufacture of radio tubes for civilian use. It is being developed in coordination with the military program. This is now nearing completion. For your information, it is expected that a list of slightly over one hundred most important types will be released for production, which will provide replacements for approximately 90% of the essential radio receivers in the country.

It is not our intention to make rash promises, or raise your hopes unduly. However, we will say that provided the WPB program can be carried through as planned, you will find substantially more replacement tubes available in the not too distant future.—Robt. P. Almy, Mgr. Sylvania Distributor Sales.

AUDIO FREQUENCY AMPLIFICATION

READERS of the February issue will recall that radio-frequency amplifiers were discussed and that something on audio-frequency amplifiers was promised to supplement the preceding data.

The audio-frequency end of a receiver (often abbreviated "A.F.") is the section following the detector. In many modern

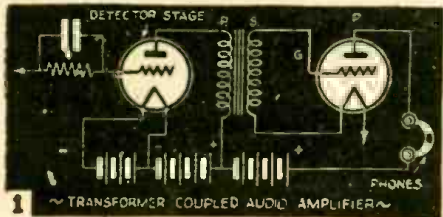

receivers it consists of only one stage, the power stage (also called output stage). In older receivers, and in some special high-fidelity models, there were two or more stages following the detector, called "First A.F." stage, "Second A.F." stage, etc.

Also you may hear or read about Class A amplifiers, Class B amplifiers, etc., and wonder what the difference is. For the present it is best to keep the attention on Class A amplifiers, and look into Class B amplifiers when you are further advanced. Almost all amplifiers as used in radios

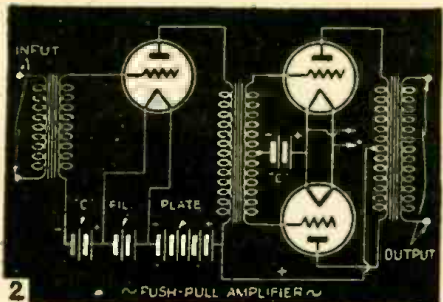

and phonograph amplifiers are Class A amplifiers. The term Class A is a classification term decided upon by radio engineers to describe the type of amplifier in which the wave form (or shape of the wave, as seen in the oscilloscope) of the output, is the same as the wave form of the signal, or alternating-current wave, or pulsation, put into the grid circuit of the tube. Also, in Class A, there is a negative voltage or "bias," of proper value, in the grid circuit at all times in order that these wave forms may agree. If they do not agree, it is called "distortion."

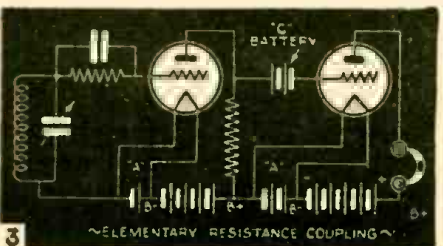

When we say the wave forms must look alike we do not mean they cannot be different in size. For they *should* be. The output wave (or output voltage as it is also called)

should be much larger in value than the input voltage in order to have amplification.

The ratio, or quotient, of output voltage to input voltage is called the *voltage gain*, or sometimes just "gain," of the tube.

These are your basic ideas associated with Class A amplifiers.

For a quick glance at Class B amplifiers we will just say that they are more powerful but at the same time have more distortion than Class A amplifiers. They are used mostly in public address work and in transmitters.

KINDS OF COUPLING

The terms used in describing different kinds of amplifiers are Resistance Coupling, Transformer Coupling and Impedance Coupling.

Resistance coupling is the simplest, the easiest to calculate and the easiest to construct. Transformer coupling is simple also, but certain points in connection with operation must be observed. And impedance coupling, at one time quite popular, is seldom used now, except in certain special circuits. The two forms most commonly used in radio and phono amplifier work are transformer coupling and resistance coupling.

TRANSFORMER COUPLING

In Fig. 1 we see a representative diagram of a *transformer coupled* amplifier, triodes (3-electrode tubes) being used for the sake of simplicity. The audio amplifier tube is connected to the output of the detector by means of an *audio frequency transformer*. Such a transformer consists of two coils wound on a soft iron laminated core, one of the coils being called the *primary* and the other the *secondary*. It will be recalled that an alternating current passing through a coil builds up a magnetic field around that coil, and through magnetic induction can cause a voltage to be impressed on another coil placed near it.

The use of the soft-iron core is to allow the maximum transfer of the magnetic lines of force, since these lines of force pass much more easily through iron than through air. The current variations of the detector output circuit are applied across the primary of the transformer. These variations of current in the primary produce a corresponding electromotive force (E.M.F.) across the secondary. Since the secondary is connected to the next tube's grid, the voltage variations will be impressed on that grid. Thus we see that the audio transformer is an electrical link between two vacuum tubes. The audio frequency current output of the detector tube, passing through the primary of the audio transformer, produces a magnetic field which in turn induces an alternating voltage across the secondary coil, and hence on the grid of the following tube. Audio transformers may act not only as a link, but as a very practical device for securing an *increase* in signal strength. This is done by designing them as *step-up transformers*.

EFFECT OF INCREASING TURNS RATIOS

Step-up transformers are so built that the secondaries have more turns of wire than the primary. Transformers may have ratios of two, three, five (or any other figure) to one, that is, the secondary may have

two, three or five times as many turns as the primary, etc., to obtain amplification.

Amplification is also secured in the tubes themselves, since it requires only a small voltage on the grid of the tube to secure a large change in the output (or plate) circuit of the tube. It might be thought that all that would be required in a transformer-coupled audio-frequency amplifier would be a very high ratio of secondary to primary turns in the transformer, in order to secure a very high step-up and maximum amplifi-

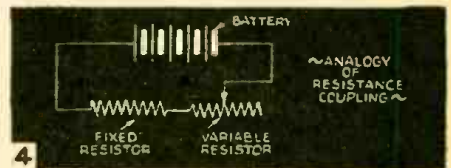

cation. However, as the ratio is increased, the problem of avoiding *distortion* and maintaining fidelity of signal becomes increasingly difficult. In a number of instances, audio transformers have a one to one ratio, that is, the same number of turns in both primary and secondary, in such cases their function is that of a coupling device between the tubes.

It should be observed that one end of the primary of the audio transformer is connected to the plate of the detector tube, and the other end of the primary to the positive potential of the B battery (or power supply). The currents flowing through the primary of the transformer may be resolved into two components; first, the direct cur-

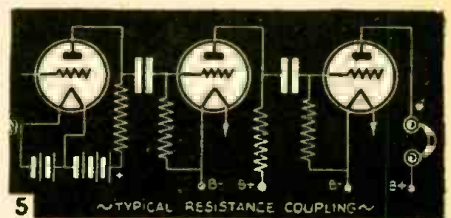

rent between plate and battery, and, second, the audio frequency current. Since there is no physical connection between the primary and secondary, the positive plate voltage of the first tube is electrically insulated from the grid of the following tube. The direct current of the detector, flowing through the primary, creates a permanent magnetic field of a certain minimum strength.

Since it is desired to transmit only the *audio frequency variations* this direct cur-

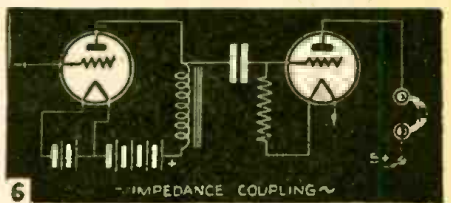

rent (necessary to maintain the plate at a positive potential) may cause distortion. This is especially true in audio transformers having a very small iron core, such that the direct current causes it to become *saturated* by the magnetic field. The use of a larger core will reduce the amount of distortion, but may cause certain losses.

PUSH-PULL AMPLIFICATION

In order to secure greater efficiency, and greater amplification, use is made of *push-pull* amplification. (See Fig. 2.) Note that in this type of amplifier, the transformers are the same as those shown in Fig. 1, except that there is a mid-tap on the secondary of the input transformer and on the primary of the output transformer.

The voltage impressed on the primary is the same as the voltage on a regular audio transformer, but since the secondary is tapped in the center, the voltage placed on the grid of each of the two tubes in push-pull, is only *half* of the voltage which would be impressed on the single tube of an ordinary audio amplifier. For this reason we must impress upon the primary of such a transformer *twice* the voltage that we would impress on the regular audio transformer. The divided voltage is united again in the output transformer. In such a system of amplification we get a balancing effect between the two tubes which permits us to work the tubes at a higher output without distortion, than we could using the same tubes in a straight audio amplifier.

RESISTANCE COUPLING

The transformer coupled amplifier is very efficient, but is not always the most satisfactory where a very high degree of quality is desired; the range of audio frequencies required in high-fidelity work is quite broad, and a transformer must be very well designed in order to pass every audio frequency with equal fidelity.

In order to avoid this difficulty, a system of *resistance-coupled* audio frequency amplification may be used. This type of amplifier, as shown in Fig. 3, takes advantage of voltage drops across resistances. In order to understand more completely how this amplifier functions, let us examine the circuit in Fig. 4. Here we have two resistors, one variable, and the other fixed, in series with each other, and the two resistors thus connected, placed across a small battery. Let us assume for the moment that the two resistors have the same value; then the voltage drop across each will be the same, the sum of these voltage drops being equal to the voltage of the battery. Now let us decrease the value of the variable resistor. This will mean that there will be less of a voltage drop across the variable, and consequently a greater drop across the fixed resistor. If we were to reverse the procedure and increase the value of the variable resistor, there would be a greater voltage drop across it, and a smaller drop across the fixed resistor.

We have an analogous situation in Fig. 5, simply by substituting a vacuum tube in place of the variable resistor. Because the resistance of the space between the filament and plate will vary depending upon the voltage on the grid, the voltage drop across the fixed resistor will vary.

It will be noted that the plate of the detector tube in Fig. 3 is connected to the positive side of the "B" battery, through a fixed resistor. It is essential to keep this voltage from reaching the grid of the next tube, but at the same time the alternating audio frequency currents must be allowed to pass. This may be accomplished by placing a "C" battery in series with the grid, in such a manner that it places a small negative charge on the grid, while the positive side opposes the positive potential of the "B" battery. The varying voltages from the preceding tube will either add to or subtract from the fixed grid voltage, making the grid alternately more or less negative, and in this fashion regulating the electron flow in the second tube.

While the circuit showing the resistance-



GOING THROUGH HELL!

Yes, going through hell... and willing to take it! That's the spirit of all America, at the front and at home. You service men of the radio industry, in the armed forces and in your jobs at home, can look to the future with hope and confidence. Victory will bring you

who are trained in the electronic arts a new era of opportunity. And National Union, in its tube research and development, is doing its part for the electronic program of our armed forces... and for your future as a service man in the field of electronics.

NATIONAL UNION RADIO CORPORATION
NEWARK, NEW JERSEY • LANSDALE, PENNSYLVANIA

NATIONAL UNION ELECTRONIC TUBES

coupled amplifier using the "C" battery is fundamentally sound, the awkwardness of using the battery, and other undesirable factors may be overcome by using the circuit shown in Fig. 5.

The small condenser allows alternating audio currents to pass to the grid of the tube, but prevents the positive plate potential of the first tube from passing. The second resistor connected to the grid of the tube at one end, and the negative side of the battery at the other end, places a small negative charge on the grid, thus eliminating the battery.

IMPEDANCE COUPLING

One of the disadvantages of the resistance-coupled amplifier lies in the fact that rather high values of plate potential are required. In order to overcome this difficulty, a type of amplifier known as *impedance coupled* is sometimes used. This is shown in Fig. 6. The circuit is very similar to that of the resistance-coupled type, the only change being the insertion of an impedance in place of the plate resistance.

AUDIO FREQUENCY OSCILLOSCOPE

By R. H. HAYWOOD

READERS who are unable to build an oscilloscope owing to shortage of components or cash, may be interested to read a description of a simple device developed by the writer which operates on similar principles to that of the Cambridge "Duddell" oscilloscope.

The source of light is a 12 volt, 36 watt lamp. The light spot (produced by means of

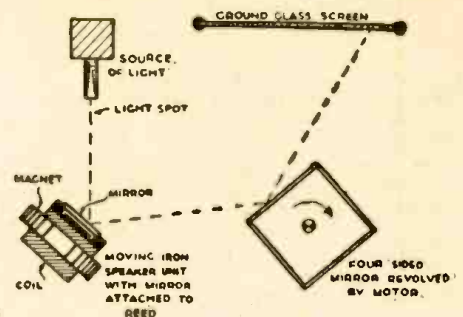

a screen, small hole and lens) is focused on to a small mirror attached to armature of an old magnetic type loudspeaker unit.

As the armature vibrates according to the audio-frequency current fed to the coil, it has the effect of varying the angle of incidence vertically. This reflected beam is thrown on to a four-sided mirror turning at approximately 500 r.p.m. which is arranged to reflect the light spot on to a small ground-glass screen acting as a scanning device.

With the armature of the loud-speaker unit motionless, the effect on the screen will be a line of light traversing from left to right or *vice versa*. Movement of the armature causes the angle (vertical) of the light spot to vary in sympathy and this will produce a sine-wave form on the screen in accordance with the audio-frequency input.

The construction of this device should present no difficulty, provided care is taken to insure that the square four-sided mirror has exact angles, otherwise the line of light on the screen will be blurred.

An electric motor with direct drive was used by the writer to rotate the scanning mirror.—R. S. G. B. Bulletin, London

TECHNICAL BULLETINS

Technical bulletins give reliable information in easy-to-follow form, and save valuable time otherwise spent in laborious reading of numerous books. Every subject is treated briefly and concisely, yet completely. No complicated mathematics, chemistry, electricity, or theory. Each bulletin is written in simple language.

PRICE \$1.00 EACH POSTPAID
ORDER BY NUMBER

ELECTRICAL DESIGN & CONSTRUCTION

D-111—DESIGNING AND BUILDING TRANSFORMERS.—Simple, non-mathematical methods for designing transformers of all kinds. Also special transformers such as are used for ultra-violet lamps, Neon tubes, etc. No complicated formulas.

D-112—DESIGNING ELECTRO-MAGNETS.—The subject of electro-magnet design is so clearly explained that anyone can design and build magnets for practically every purpose. Complete. Practical data covering both A.C. and D.C. magnets.

D-113—HOW TO DESIGN SOLENOIDS AND PLUNGER MAGNETS.—Anyone who is interested in solenoids or plunger magnets cannot afford to be without this non-mathematical, simple and practical information.

D-101—USING NICHROME RESISTANCE WIRE.—Explains how to repair electric flat irons, toasters, rheostats, resistors and other electric heating devices. Simplified methods of figuring lengths and sizes of wire for any job.

D-106—REWINDING ELECTRIC MOTORS.—Complete information, diagrams, sketches, tables, etc., to enable any shop man, mechanic, electrician, experimenter, etc., to rewind A.C. and D.C. motors and generators of all types. For the man who wants to know "how" rather than "why."

D-144—A.C. CURRENT CONTROLLED WITH EASILY MADE CHOKE COILS.—How to design and construct choke coils. How to determine size and amount of wire required, how to find the core size. Full details on assembly and coil winding.

D-148—DESIGNING AND USING ELECTRIC RELAYS.—Simple practical instructions for designing, building, and using A.C. and D.C. relays; also thermo-electric relays. Includes practical relay control systems for motors and machinery.

D-127—SMALL ELECTRIC LIGHT PLANTS. DESIGN AND CONSTRUCTION.—Tells how to design and build small electric light plants for cottages, camps or country homes at small cost. Covers construction of a 110-volt system to light six 30-watt lamps, how to build a 6-volt system using an auto-generator, with or without a battery, and how to convert a Ford model "T" generator to a 110-volt, A.C. generator.

D-134—ELECTRICAL EXPERIMENTS WITH SIMPLE MATERIALS.—How anyone without previous knowledge of electricity can perform harmless, interesting, and educational experiments with simple, inexpensive materials.

D-131—MODEL MAKERS & INVENTORS GUIDE TO REMOTE-CONTROL SWITCHING.—Controlling electrical devices, train models, equipment of all types at a distance by means of a telephone dial.

D-137—ELECTRICAL METERS EASILY BUILT.—Information that will enable students to build experimental electrical meters to measure alternating or direct currents. Including ammeters, voltmeters and wattmeters sufficiently accurate for experimental purposes.

D-136—SMALL A.C. ARC WELDER CONSTRUCTION AND USE.—Tells how to build arc welders capable of fusing iron and steel sheet up to 3/16 inch in thickness and rods as large as 1/2 inch in diameter for use on 110-volt, 60-cycle A.C., 110-volt 25-cycle A.C., or on 220-volt 60 cycle A.C.

Each Bulletin consists of a set of large sheets, assembled in one packet, size 9 x 14 1/2"; weight 1/2 lb. Numerous illustrations, diagrams, charts to supplement text.

TECHNIFAX

1917 S. STATE ST. RC343 CHICAGO, ILL.

TECHNIFAX 1917 So. State, Chicago, Ill. 343

Enclosed find \$_____ for which please send me Postpaid the following Technical Bulletins:

Nos.

Name

Street and Number

City and State

HANDY RADIO TESTER

By W. NEELANDS

THESE ideas are intended to show how the chap with limited radio knowledge, equipment and time, can help out. Radio repair shops are full to overflowing. You can help the situation and do your neighbors a good turn by fixing their radios. That's just one of the places where the apparatus to be described can be used.

We claim that you can do more things with this outfit than with any other 4-tube hook-up yet published.

The thing that makes it so versatile is the idea of bringing the 6 points out to pin jacks mounted on a small Bakelite switch-board centrally located on the larger metal or plywood panel.

Little need be said by way of building instructions.

1. Plan your layout, type of chassis, panel, etc., having regard to type, size and mounting-style of chokes, transformers, and condensers that you intend to use.

dial until signal comes through radio. Note reading on dial. There you have a modulated I.F. wave coming from your signal generator. It can be used on a defective radio.

2. Plug in coil No. 2. Probes still in Nos. 2 and 3. Now it's a signal generator operating on the broadcast band. (The radio in the next apartment won't like it).
3. Now as a signal tracer. Plug into 4 and 3. Strong audio signals can easily be detected, thus isolating a defective speaker or output transformer.
4. Plug into 6 and 3. Even quite weak audio signals will be amplified to good volume.
5. In fact it makes a very nice record player. Dig out the old turn-table and pick-up. The tone control can be adjusted to eliminate scratch and treble can be attenuated to suit taste.

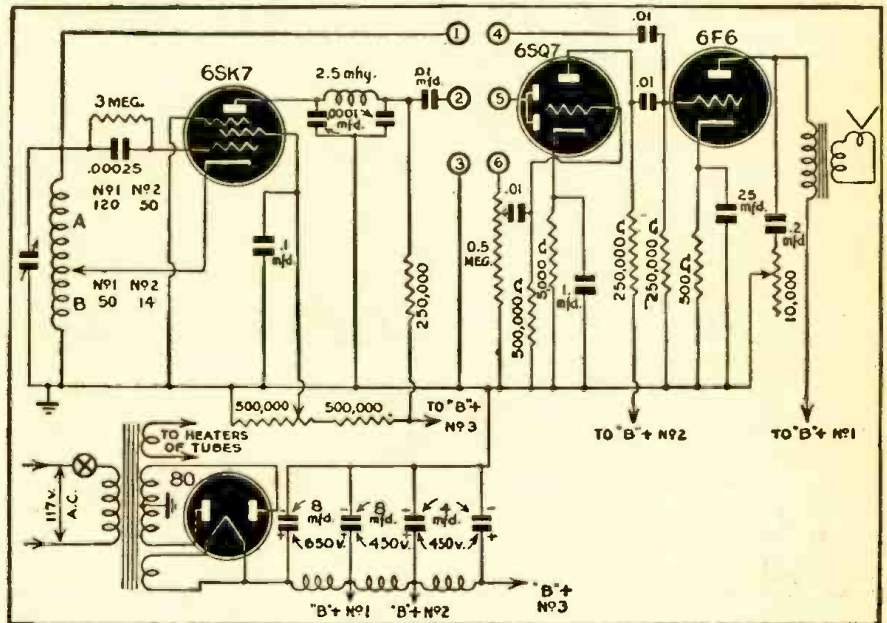

2. If you use the single-ended metal tubes as indicated, you can make a really neat job; other types of course may be at hand and may lower the cost.
 3. The 6F6 was triode-connected in the author's outfit because the power transformer was a tiny affair and wouldn't stand the drain of a pentode. No doubt pentode connections would give greater output.
 4. Perhaps you think that all that B-plus filtering isn't necessary. O.K., do it your way, but it does provide excellent decoupling between stages.
 5. Keep grid and plate leads very short. Note that some of the leads running to the pin-jacks are of this nature. They must be carefully shielded.
 6. Use as big a dynamic speaker as is available. An 8-inch one is very nice, but a 10 or 12 inch would be better.
- Now let's concentrate on what can be done with a good probe-cable, the two coils, and those six pin-jacks. Here's where the fun begins.
1. Plug in coil No. 1. Plug probe into jacks Nos. 2 and 3. Turn up the regeneration. Touch probe No. 2 to grid of I.F. tube of radio in good condition. Turn tuning

6. Or, if you have a small mike, there's some extra fun, singing, speech-making, calling-off, mixing programs.
7. A contact mike on a little uke, or under the tail piece of a violin will really build it up. (The party ought to be a big success).
8. Plug into 5 and 6. Strong I.F. or R.F. signals can be detected.
9. Plug in coil No. 1. Plug into 1 and 3. Join Nos. 2 and 6 with short wire or small paper condenser. Weak I.F. signals can be tuned in from defective radio.
10. Plug in coil No. 2. Other connections as in No. 9 above. R.F. signals can be tuned in from defective radio right back to aerial.
11. In fact all you need do is hook an aerial to No. 1 and a ground connection to No. 3. Adjust controls, and the outfit makes a good broadcast receiver.
12. And its also a good enough short-wave receiver. Make up a few coils on old tube bases while you're waiting for the next sick radio to come in, and see for yourself.



"Here's How"

VOLUME CONTROL

Contest

Pays \$500⁰⁰ in WAR BONDS

Do you know how to make a sick radio sit up and *sing*? Would you swap a few minutes' time for a \$100 U. S. War Savings Bond? O.K. . . . if you live within the boundaries of the United States—you're qualified. Not only one, but FIVE, \$100 Bonds are offered! Let's go!

Nobody knows better than you how important the radio is to a democracy at war. And nobody knows better how difficult it is sometimes to get a radio into working order . . . what with the difficulty of getting exact replacement parts, etc. The question is: HOW DO YOU DO IT? IRC is going to pay a \$100 Bond each for five answers. Don't you agree one of them might as well be delivered to YOU?

HOW TO WIN A BOND!

All that's required is a simple account, told in your own way, and your own words, describing:

How you were able to replace a volume control and get the set working satisfactorily—when you couldn't obtain the volume control you would ordinarily have considered necessary for that particular make and model of radio.

Name the make and model instrument you were working on. Tell what the VOLUME CONTROL trouble was. Describe exactly what you did and why, whether you made certain mechanical changes in the substitute control and/or electrical changes in the circuit.

IRC suspects that in these times radio service men are displaying more ingenuity and inventiveness and resourcefulness than most of us have any idea of. We'd like to uncover some of these stories.

It's the IDEA that Counts

Remember, no one expects you to submit a literary masterpiece. Your spelling makes no difference; grammar doesn't matter. Just "let yourself go" and tell us how you licked the volume control problem you faced (it may have been as simple as filing down a shaft, or making a special shaft), and send the story in.

You May ALREADY Have Won a Bond

What we mean is that some Volume Control job you've already done may be the one to cop one of those Bonds. It may be only a matter of putting down the detailed facts and mailing your entry!

IDEAS to be Shared

In entering this contest you have the satisfaction of knowing that worth-while ideas will be publicized for the entire service profession. You yourself will benefit from the information made available by the results of this contest. This exchange of ideas is certain to help you keep radio sets going, through the use of standardized controls. These same sets might otherwise be kept out of service and become lost jobs for you.

The Judges

Judges, whose decision will be final as to the five winning entries, include IRC's Chief Engineer, Jesse Marsten, and two "outside" experts—Joseph Kaufman, Director of Education of the National Radio Institute, and William Moulie, Service Editor of "Radio Retailing Today." If, in the opinion of the judges, winning ideas of equal merit are presented, duplicate awards will be made. It is understood, of course, that all ideas submitted become the property of IRC.

WHAT HAVE YOU GOT TO LOSE?

Don't say, "Aw, the Volume Control job I'm thinking of was too easy—any good radio man would have done the same as I did." Remember this: ANY job looks easy when you know the answer. . . . And besides, even if someone else did have the same idea, HE may not tell us about it. So get busy yourself—surely a crack at one of those \$100 Bonds is worth some trouble! All entries must be in IRC's hands by April 10, 1943 when contest closes.

FILL OUT THE COUPON

—and send it in with your entry this week—**TODAY** if possible. Don't put it off. Five men are going to be richer by a \$100 Bond—make one of them **YOU!**

Uncle Sam's Men, Too

If you're now in Government service, in or out of uniform, you're still eligible in this contest. Maybe the job you did was handled before you went into the service.



CLIP THIS—FILL IN—SEND IN WITH YOUR ENTRY

INTERNATIONAL RESISTANCE COMPANY

401 N. Broad St., Philadelphia, Penna.

● Gentlemen: Here is my entry in your \$500 U.S. War Savings Bonds Contest.

MY NAME _____

COMPANY _____

ADDRESS _____

CITY _____ STATE _____

MY REGULAR DISTRIBUTOR IS _____

RC3

U. H. F. RECEIVER

By STANLEY DOWGIALA

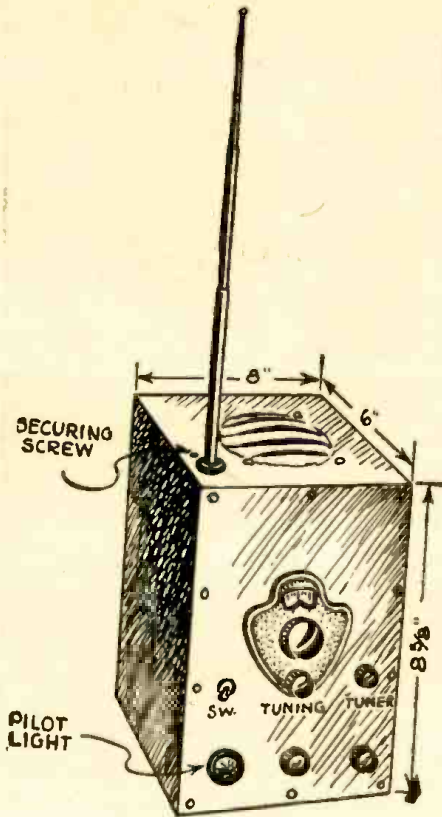

The Dowgiala U.H.F. Special.

ALTHOUGH this receiver was built primarily for police work, it can also tune-in FM stations with the aid of different coils.

Here are some of the FM stations received with plenty of "wallop"—W2XMN, W47NY, W2XWG, W2XQR, W67NY, and W71NY. The coil windings for FM were as follows: 8 turns of No. 14 enameled wire on 3/4-inch diameter forms, tapped at 3 turns from ground.

A resistor from the cathode of the 6K7 brings in the "rush" where there is a "dead" spot, and helps bring in a weak station. Experiments should be made with different values of resistor.

Police calls were received on U.H.F. from Newark, Jersey City, New York, Union City and Bayonne. For these coils wind 12 turns of No. 14 wire on 3/4-inch diameter forms, tapped at 3 turns from the top.

Television stations also have been received, but I have no accurate coil data to cover them, for only a few were received

with the experimental coils. Station WNBT was the one most often received.

The speaker used was 5-inch diameter Crosley type dynamic, with the field hooked up in the power supply circuit with the minimum of hum.

The tuner (the variometer coil) was salvaged from an ancient Zenith radio. I show in the sketch what it was like so others may build one like it.

The antenna was salvaged from a car radio and was cut down to the desired length. When mounting it on the cabinet a hole was bored in the top of the cabinet and a rubber grommet inserted. At the base of the antenna was fastened a porcelain socket filled with solder. Then a hole next to the rubber grommet was drilled and a screw to hold the socket in place put in and a nut added to tighten everything up.

The audio choke was salvaged from an old Philco set.

The cabinet such as I used can still be obtained in some radio supply stores.

I found the tuner worked better than a trimmer or small variable condenser. There is no body capacity, and it brings in the weak stations with greater selectivity.

The tuner can be hooked up any way desired, as it always functions well. The loose coupling connection is wound once around the coil. The coupling coil is regular hookup wire to which is attached the No. 28 double-cotton-covered lead-in from the antenna.

Notice that a 6L6G tube is used in the output stage. A 6V6 will work just as well. I am not going to go into a lot of detail about this receiver because almost anyone can build it and will appreciate having one.

I realize that there are a lot of experimenters and set constructors who have had quite a bit of experience and will know what steps to go through to make a receiver like this, and will know how to iron out any kinks or "bugs" that they encounter in its operation. The whole idea is just to give the boys something to work on and experiment with.

I gave this receiver a good test and found it to be more than satisfactory for the use of the various departments. At present I am an air raid warden and can be on my post before the siren's blast.

Here is my slogan for the radio man. "Keep the air waves open!"

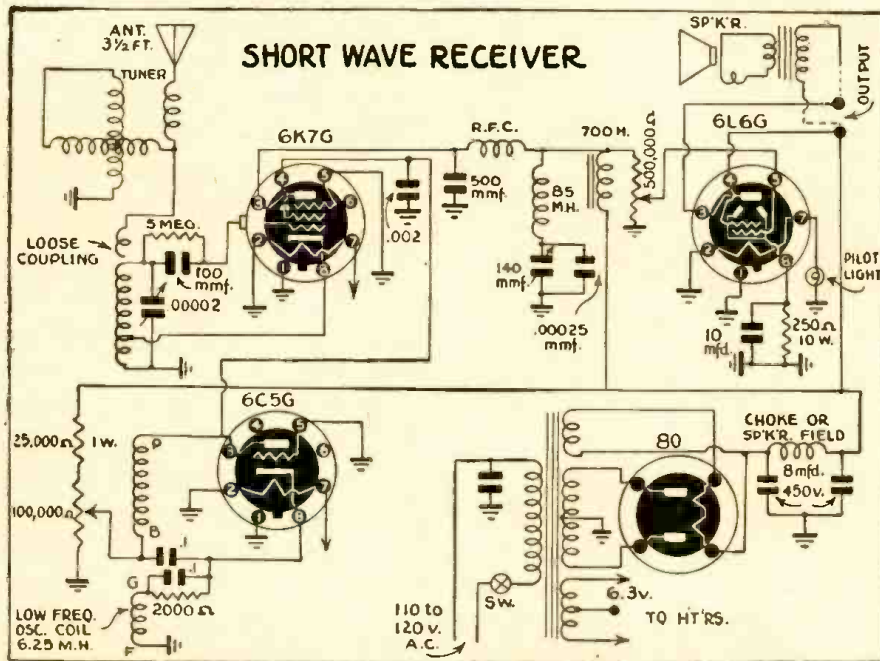

TUBE "SHORTS"

RECENTLY we have received a considerable number of complaints on battery type tubes which indicated that commercial tube checkers were showing up tubes as having grid-filament shorts. In many instances it was reported to us that the tubes worked perfectly satisfactory in equipment. In other instances tubes were sent back to us for analysis. Our analysis showed that there were no short circuits between filament and grid. An investigation was made of several commercial tube checkers in which these defects were being noted to ascertain the cause for such indicated shorts, when in reality no shorts were present.

When one stops to analyze just what is occurring, it is fairly easy to see the reason for the discrepancy. In a commercial tube checker, for simplicity reasons, it is usually a practice to make available only one supply voltage. For most types of tubes the value of this voltage is not too important and consequently a value usually above 150 volts is employed. When filament-grid shorts are being checked, however, on any kind of a tube, since the spacing between these elements is very close, the voltage gradient is very high and a considerable electrostatic attraction exists. In the case of 1.4 volt tubes this force is sufficient to attract the

filament over to the grid. This results in a grid-filament short being indicated since the filament may actually touch the grid under these conditions. With the proper equipment it is possible to actually see the filament being attracted to the grid structure. In manufacturing these tubes a great deal of difficulty was experienced with this condition until it was recognized that the voltage between grid and filament must be kept at a low enough value so that the filament did not become distorted. This can readily be accomplished by reducing the value of this voltage without any attendant harm
(Continued on page 379)

PRACTICAL RADIO INFORMATION

Including Frequency Modulation—Television, etc.



Inside Information for all Servicemen—Aircraft Pilots, Students.

772 PAGES, 400 DIAGRAMS
is complete—gives Authentic Principles & Practices in Construction, Operation, Service & Repairs. Covers clearly and concisely Radio fundamentals—Ohm's Law—Physics of sound as related to radio science—Measuring instruments—Power supply—Resistors—Inductors—Condensers—Transformers and examples—Broadcasting stations—Radio Telephony—Receivers—Diagrams—Construction—Control systems—Loud speakers—Antennas—Auto Radio—Phonograph pickups—Public Address Systems—Aircraft & Marine Radio—Radio Compass—Beacons—Automatic Radio Alarms—Short Wave—Coil Calculations—Testing—Cathode ray oscillographs—Static Elimination—Trouble Pointers—Underwriter's standards—Units & tables. REVIEW QUESTIONS—Ready Reference Index.

\$4 COMPLETE • PAY \$1 A MO.
To get this practical information in handy form—Fill in and

— — — — — MAIL COUPON TODAY — — — — —

AUDEL, Publishers; 49 West 23rd St., New York
Mail AUDELS NEW RADIOMAN'S GUIDE for free examination. If O. K. I will send you \$1 in 7 days; then remit \$1 monthly until \$4 is paid. Otherwise I will return it.

Name _____ R.C.F.
 Address _____
 Occupation _____
 Reference _____

Please Note:
If you do not wish to mar this page by clipping coupon—send letter or penny postcard instead.

PORTABLE BATTERY PHONO OSCILLATOR

By LEE GARRISON

In past issues of *Radio-Craft*, and in the old days, in *Radio & Television*, I have noticed phono oscillators described that were said to be portable.

There was just one thing about them which I did not care for—they all depended on the 117-volt power lines for operation.

I know that out in the country, away from the power lines, the farmers also have radios. Those radios depend on battery power.

If a farmer wishes to play the records through his radio, he has to get a service man to cut in a jack for him to plug in the phono pickup. That works all right, but when he wants to play the radio, he has to remove the phono pickup.

We have tried that stunt but the folks did not seem to like the tone of the music. When we use a phono oscillator, the music seems so much better.

When you use the entire set to reproduce the music, needle scratch is practically absent.

The three-way 1D8GT tube—diode, triode, and pentode, all in one envelope, makes a compact oscillator possible.

This oscillator measures only 4½ inches by 5¾ inches by 3½ inches. The batteries are contained in the cabinet, and it is independent of the power lines.

In selecting the circuit to be used, I chose the one used in the Meissner phono oscillator. The 6F7 and the 1D8GT are practically alike in internal construction. Using the same circuit, except for minor changes, the results are the same. The changes include different power supplies, home-wound oscillator coil, volume control to control the modulation percentage, and a different way to couple the output of the oscillator to the radio.

The pentode section of the 1D8GT was not biased, as it was not found necessary to do so. The resistance used keeps the plate voltage and current down to a safe level, as measured at the plate terminal.

The cabinet was made from a couple of cigar boxes. The wood, being so thin that screws could not be used, I settled on two straps obtained from the ten-cent store to hold the front panel in.

When the front panel is removed the oscillator and the batteries come out; this makes changing of batteries easy.

Airplane type luggage linen covering would make a very attractive covering for the cabinet, and it would also harmonize with most of the portable radios.

The size "D" flashlight cell should give

about five hours of service before it needs replacing. The "B" battery should give more than four hundred hours of service. If the oscillator is not to be portable, a larger size "A" supply can be used, notably, a No. 6 dry cell, which will give about two hundred hours of service before replacement is needed.

You will see that I have specified five coil forms in the parts list. This is necessary, as they are sold in kits of five only. Also that I say the coil dope is not needed, unless the oscillator is to be used where it will collect moisture.

To be safe, I would recommend that the "dope" be purchased and used. One never knows where he will take a portable outfit like this, and it does not take much moisture to cause trouble. I know from experience with an undoped loop antenna on a portable radio. When the loop got damp (and you couldn't feel the dampness, either), I couldn't even raise a station twenty-five miles away!

I have used this oscillator for about a month, and it has always given excellent performance. I loaned it out to some of the farmers just to see how good it was.

When they returned it they said that the tone was good and that the music sounded just like that received from the broadcast stations.

Primarily, this oscillator was built to see if the rural dweller couldn't be given the same chance at good music that their city cousins have.

Parts List

- I.R.C.
2—100,000 ohms, ½ watt resistors
1—250,000 ohm, ½ watt resistor

NEW ENGLAND RADIO-CRAFTERS

- 5—Radio-Crafter "C" coil forms (five, as no less than that are sold)
1—Bottle Polystyrene No. PDQ coil dope, to dope coil (not really needed unless oscillator is to be used where it will collect moisture)

BUD RADIO CORPORATION

- 1—Midget jack and plug

CENTRALAB

- 1—100,000 ohm volume control with A.C. switch

AEROVOX

- 3—.01 mf. volt paper condensers
1—.00025 mf. mica, midget condenser
1—.0001 mf. mica, midget condenser

MEISSNER

- 1—.00025 mf. variable padding condenser

NATIONAL CARBON CO. (Batteries)

- 1—#482 Minimax 45 V. "B" with plug
1—Size "D" flashlight cell, or 1 #6 dry cell

MISCELLANEOUS

L is wound with #32 enamel wire, 170 turns. Winding space one and one half inches. The tickler is wound over the bottom end of the coil. A strip of paper wound on the bottom end of the tuning coil first and tickler wound on that. Otherwise there is not enough room on the coil form for it. Tickler winding is 40 turns of #32 enamel.

Circuit diagram of a phono oscillator for use in rural sections. It fills a long-felt want.

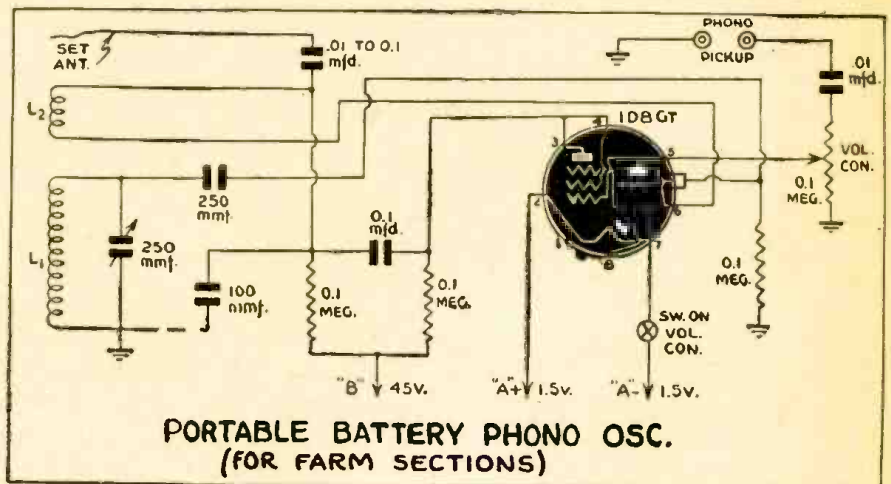

SHORTWAVE CRYSTAL SET

The tapped coil on this set has a 3-inch diameter, having 15 turns of No. 30 wire double tapped at every third, sixth, ninth and twelfth turn. It also has a tap at the top. The tuning condenser is 140 mmf., but others will work. A crystal must be used.

In the simpler diagram the coil has a 2-inch diameter having 90 turns of No. 28 D.S.C. close-wound. The tuning condensers can be any size available, from 15 to 21 plates, but in any case they should both have the same amount of plates.

JOHN HAYNES
Doe Run, Mo.

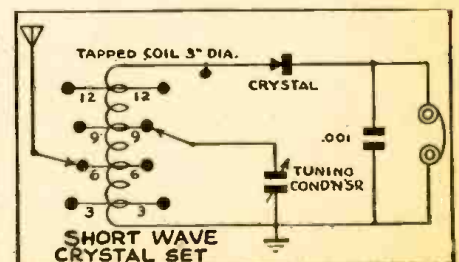

This circuit uses taps for aerial tuning and both taps and condenser in the crystal circuit.

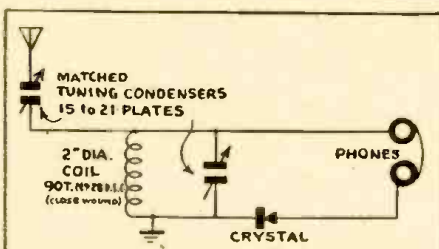

ELECTRONIC TONE CORRECTOR

This is a novel dual channel device with separate controls for high and low frequency attenuation. This is an entirely new idea for use in P.A. systems, which I believe the boys would like to have.

You will notice that entirely separate channels and amplifiers are used for high and low frequency compensation.

In observing the diagram you will notice the 6L5 tubes are preceded by a preamplifier stage of the grids of those tubes which

frequencies only. The amount of signal on the grids of the 6C8 and 6L5 tubes can be varied by the grid potentiometer.

Since the signal has now been broken down into two separate channels so that they can be individually controlled, it is again necessary to combine the outputs at those tubes. This is done by coupling the plates at each of these tubes through a .05 mfd. condenser to the grid of the driver stage.

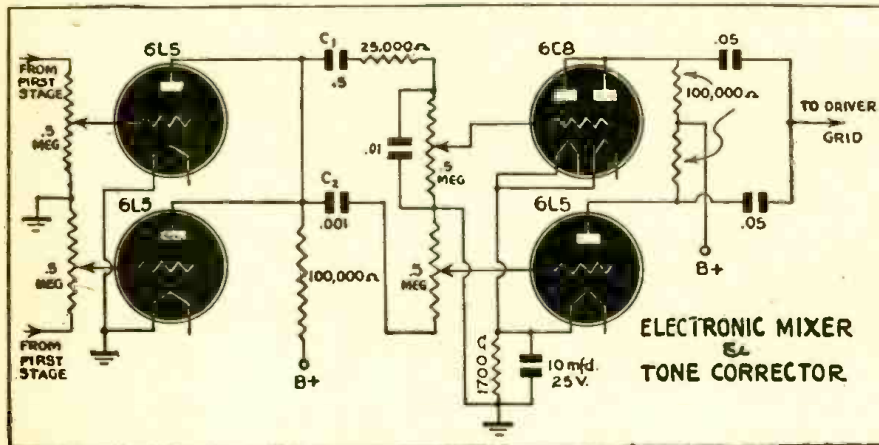

may be excited separately; that is, four separate mikes or phone inputs may be mixed in this stage.

The plates of this stage are in parallel so that a single output connection is available. From this point the tone corrector action takes place.

The grids of the parallel 6C8 are coupled to the mixer stage through a potentiometer and a .5 mfd. condenser. The purpose of this tube is to pass bass frequencies only, thus the extremely large coupling condenser C-1 connected in parallel with this network is the grid circuit of the 6L5. This is the high frequency channel.

The small condenser C-2 will pass high

in combining the signals the full frequency range is under constant control at the separate bass and high potentialities.

This is about the best way to control your P.A. system and enjoy your recorded music when played over your P.A. system.

STANLEY DOWGIALA
Jersey City, N. J.

(Through an oversight the tube under the 6C8 is marked "6L5". It should be another 6C8.)

Also note that the cathode bias resistor of 1700 ohms for the two 6C8's was computed on the basis of a plate voltage of 250-volts, and a plate current of 4 mils.—Editor)

UNUSUAL USES OF SHORT WAVE

By V. N. KASSANDROFF

Metallurgical Engineer

THE experimental evidence indicates that ultra-short waves in the neighborhood of one centimeter, penetrate a great many solids which are opaque to light, such as metals, alloys, plastics, synthetics, and the like. Thus these short waves, sometimes competing with X-rays and gamma rays (industrial radiography), and sometimes supplementing them, provide a powerful and inexpensive tool of many uses in research, particularly in the study of internal structures, or for detecting internal defects.

The simplicity of the equipment required, and of its installation; its low power-consumption, portability, safety, and over-all costs, etc., constitute factors which favor its preferred use wherever practical to do so. The apparatus can be used for quick visual observation concurrently with magnetic inspection, or independent of it.

In extending the field of useful applications of radio, it is believed that the law of magnetic octaves (induction), previously referred to, can be of service not only in communications or as an electrodeless relay, switch, robot, or activator, but also can be used to augment efficiency in detecting and exploding land-mines, and to increase the range over which this detecting and

exploding takes place.

Anything that moves on the ground or in the sky could operate this device, its design incorporating the ideas derived from this law.

Again, all-metal planes, landing on the all-metal tops of aircraft carriers, represent a capacitor, with metal plates meshed "in" or "out" at the point of landing. This principle could be used to develop and design the instruments to control "blind" landings, under conditions of limited visibility, particularly at night.

The instruments could be made operative from the carrier, or by combined action of plane and carrier, or preferably as self-contained and independent plane instruments.

It is evident that in addition to a perfect three-point landing curve, the instruments must provide a directional guidance, which is not so difficult so far as the carrier is concerned, even at night.

The choice of wavelength, as regards freedom from interception, points favorably toward frequency modulation, with the waves partaking of the nature of "quasi-optical" and elliptically, circularly and cylindrically polarized radio waves.

GEOPHYSICAL PROSPECTING PRINTS TREASURE FINDERS



50c EACH

BLUEPRINTS and INSTRUCTIONS

For Building the Following Treasure Finders and Prospecting Outfits

Folder No. 1. The "Radioflector Pilot"—consists of a 2-tube transmitter and 3-tube receiver. Principle: radiated Wave from transmitter loop is reflected back to receiver loop. Emits visual and aural signals.

Folder No. 2. The "Harmonic Frequency Locator"—Transmitter radiates low frequency wave to receiver, tuned to one of Harmonics of transmitter. Using regenerative circuit. Emits aural signals.

Folder No. 3. The "Beat-Note Indicator"—Two oscillators so adjusted as to produce beat-note. Emits visual and aural signals.

Folder No. 4. The "Radio-Balance Surveyor"—a modulated transmitter and very sensitive loop receiver. Principle: Balanced loop. Emits visual and aural signals. By triangulation depth of objects in ground can be established.

Folder No. 5. The "Variable Inductance Monitor"—a single tube oscillator generating fixed modulated signals and receiver employing two stages R.F. amplification. Works on the inductance principle. Emits aural signals.

Folder No. 6. The "Hughes Inductance-Balance Explorer"—a single tube Hartley oscillator transmitter and sensitive 3-tube receiver. Principle: Wheatstone bridge. Emits aural signals.

Folder No. 7. The "Radio-dyne Prospector"—a completely shielded instrument. Principle: Balanced loop. Transmitter, receiver and batteries enclosed in steel box. Very large field of radiation and depth of penetration. Emits aural signals.

With any one of the modern geophysical methods described in the Blue-Print patterns, radio outfits and instruments can be constructed to locate metal and ore deposits (prospecting); finding lost or buried treasures; metal war relics; sea and land mines and "duds"; mineral deposits; subterranean water veins; oil deposits (under certain circumstances); buried gas and water pipes; tools or other metallic objects sunken in water, etc., etc.

Each set of blueprints and instructions enclosed in heavy envelope (9 1/2" x 12 1/2" x 3/4"); eight-page illustrated 8 1/2" x 11" folder of instructions and construction data 50c

The complete set of seven folders \$3.00
Shipping weight 2 lbs. (add 25c for shipping anywhere in U.S.A.)

TECHNIFAX

1917 S. STATE ST. CHICAGO, ILL.

TECHNIFAX 1917 So. State, Chicago, Ill.

Enclosed herewith \$..... for which mail to address below:

Treasure Finder No. 1, 2, 3, 4, 5, 6, 7,

Complete set of seven folders.

NAME

ADDRESS

CITY STATE

RC-343

QUESTION BOX

By FRED SHUNAMAN, Technical Editor

QUERIES

All queries should be accompanied by a fee of 25¢ to cover research involved. If a schematic or diagram is wanted please send 50¢ to cover circuits up to 5 tubes; for 5 to 8 tube circuits, 75¢; over 8 tubes, \$1.00.

No picture diagrams can be supplied.

Back issues 1942, 25¢ each; 1941, 30¢ each; 1940, 35¢ each.

Any issue, prior to 1940, if in stock, 50¢ per copy.

T.R.F. RECEIVER

? I would appreciate seeing a diagram of a three-stage T.R.F. tuner, preferably 6SK7, 6SK7, 6SJ7 or 6C5.—G. M., Toronto, Canada.

A. We are reprinting herewith a diagram of the 7-tube T.R.F. receiver which

appeared in Radio and Television for July, 1941. The section to the left of the phono-radio switch is the diagram you want. The whole schematic is printed for the benefit of those who might like to construct a high-fidelity T.R.F. receiver.

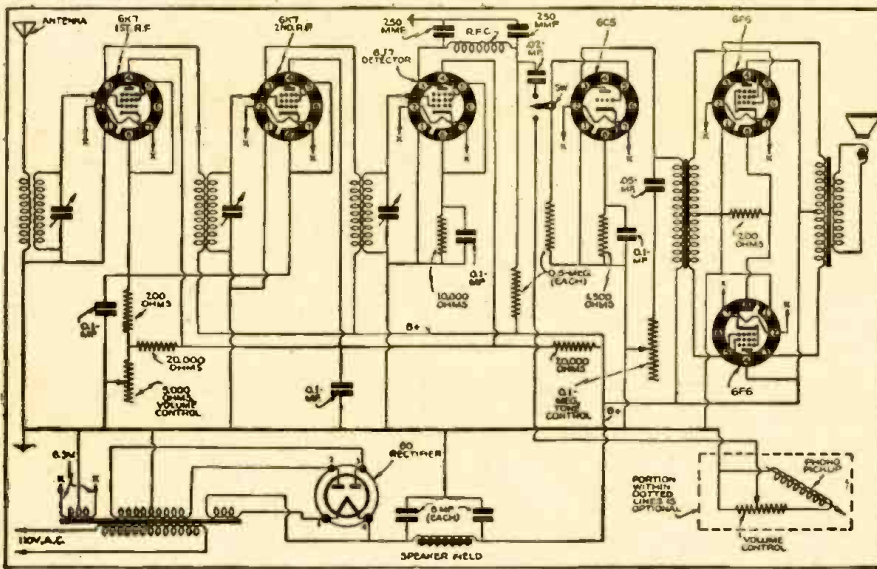

MODULATED OSC.

? I have a great number of Radio-Craft magazines but cannot find a nice little modulated oscillator to be used with plug-in coils. I would like to have something using one or two 1.4 volt tubes.—F. M. Glenham, S. D.

A. Why not revise the diagram on Page 729 of the Aug.-Sept. issue to use 1G4G's? The coils are of the 3-terminal type, especially adapted to plug-in. Batteries can readily be substituted for the power pack shown.

PHONO OSC.

? You printed a diagram of a portable phono-oscillator about last June. I think it used a 1D8-GT. Since I have lost all my old magazines since going on active service, I would appreciate it if you would reprint this diagram.—J. K., Aberdeen, Md.

A. The diagram here printed may be the one you want. It uses a 1A7-GT.

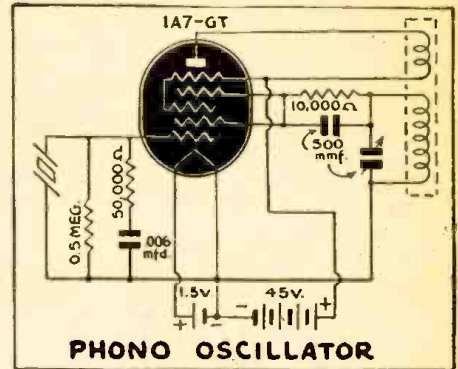

5-METER SUPERREGENERATOR

? Please print a diagram of a 5-meter 1-tube superregenerative receiver, using battery-type tubes and portable batteries.

A. Herewith the diagram. The tubes may be 1G4-G's or the loktal 1LE3. L1 may be 10 turns of No. 14 tinned wire, 1 1/4 inches long, diameter 3/4 inch. R.F.C. must be a special U.H.F. choke. Superregeneration is controlled by the 5 megohm resistor and C2 which should be variable between about .001 and .002. Better use a pair of .0005 mica and a mica padding condenser with a maximum capacity of .0005 or as near that as obtainable. C1 may be a special U.H.F. variable or a midget variable with all but two rotor and one stator plate removed. Connections are shown for an optional audio stage, as a 1-tube set is not likely to be entirely satisfactory.

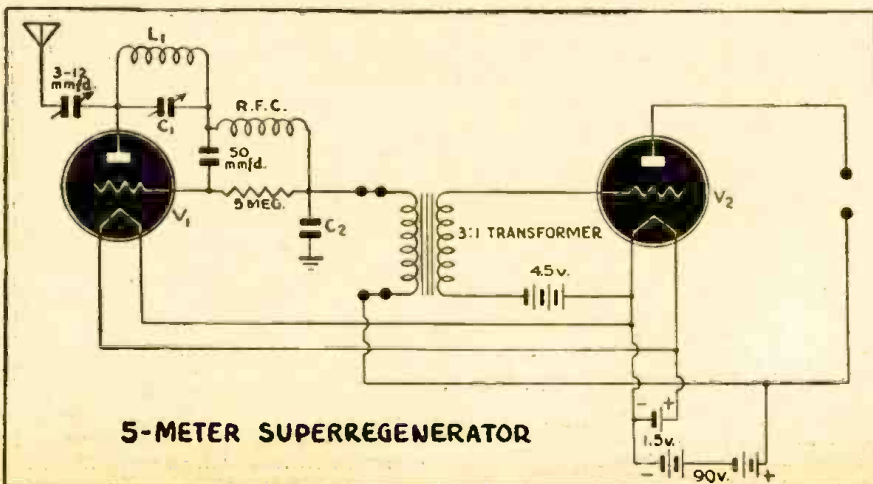

coil may be a broadcast coil from an old T.R.F. receiver, and the condenser should have a maximum capacity of from .00035 to .0005 mfd.

WINDING COILS

? Will you please tell me how to wind a coil to listen to the broadcast band with my short-wave receiver? The condenser has a capacity of .00014 (140 mmfd.)—F. X. O., Richmond, Va.

A. Two coils will be necessary to cover the broadcast band with this variable condenser. They may be wound as follows:

Grid Coil Turns	Winding Length	Size of Wire	Tickler Turns
80	1 1/4 in.	No. 28	12
150	1 1/2 in.	No. 30	18

The coils are to be wound on standard 1 1/2 inch coil forms. Wire is enamel insulated. The tickler may be wound with No. 32 or other fine wire.

BATTERY TESTERS

? I have a battery volt ammeter 0-50 volts. Will you please print a circuit for making a volt ohm-milliammeter from this? —W. L. W., Shenandoah, W. Va.

A. Battery testers of the type you describe are not as a rule suitable for making radio test instruments, as they draw too much current, and would upset circuits into which they were introduced to make measurements.

FOUR-TUBE SET

? Please give me a diagram for a very small 4-tube set, using the miniature-type tubes, and working from the line. I have a 50,000 ohm volume control and a 2-gang .00035 mfd. variable condenser. Would prefer to have it work with a loop.—J. C. Gruber, Okla.

A. The diagram here shown will work either with phones or a small speaker. A small set of this type is hardly sensitive enough to operate with a loop—better use a flexible throw-antenna of from 20 to 40 feet of insulated "flexible aerial" wire.

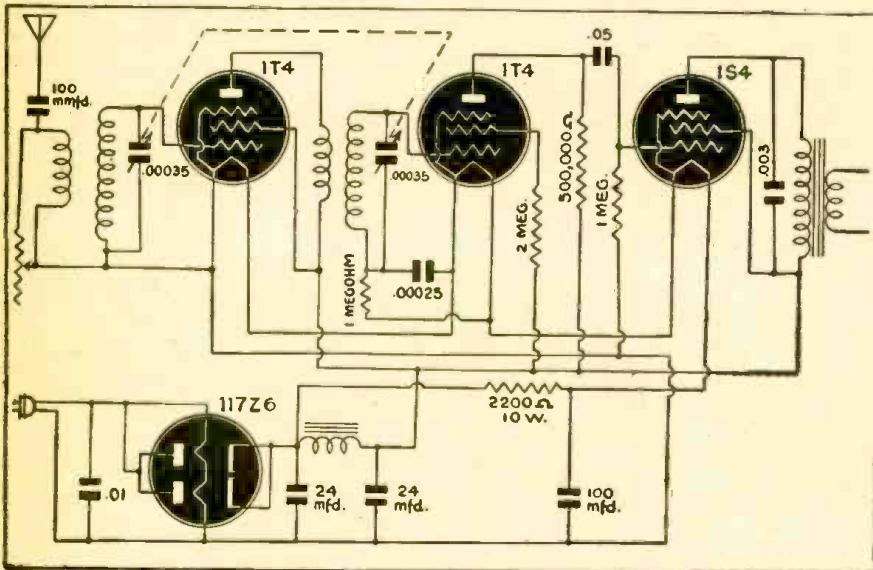

SMALL P.A. AMPLIFIER

? Please give me a diagram of an amplifier like a very small P.A. system, to work with a carbon microphone, and using a 6C6 and a 41.—D. E. B., Clifton, N. J.

A. The diagram here given should have gain enough to work with a single-button carbon microphone, and should also be satisfactory as a small phonograph amplifier.

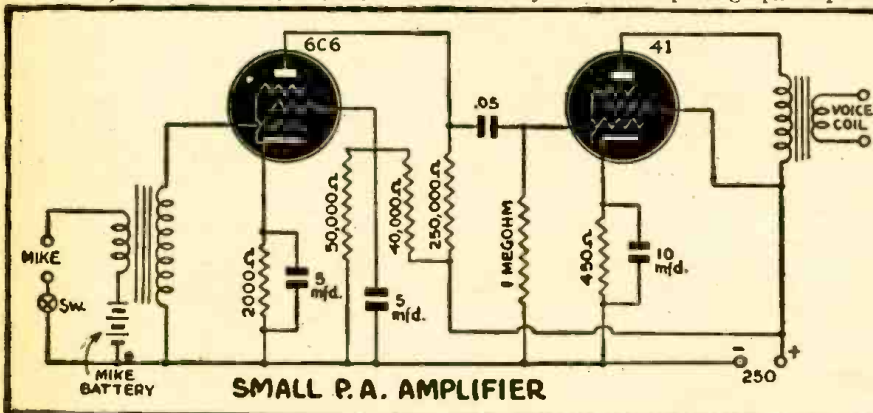

RADIO EDUCATION FOR WAR

HIGH SCHOOLS, colleges, vocational schools,—all of them are now geared to wartime demand for technicians, as contrasted to the usual peacetime output of intellectuals and white-collar workers.

Liberal arts courses are being dropped, shortened or revised where needed to supplement professional technical training, but in the pre-service radio training courses

stress is laid upon the basic theory of the subject, which consists of mathematics, electricity, and physics.

Tied up with this project is the problem of getting instructors. Men who formerly taught history or French or mathematics are now brushing up on electrical theory, so their teaching ability can be utilized to best advantage.

GUARDING COMMUNICATIONS WHERE THE GOING IS TOUGH!

SUPREME

TESTING INSTRUMENTS

The famous 504-A and other SUPREME Testing Instruments are on active duty in all parts of the world. Now more ruggedly built, more accurate and dependable than ever. SUPREME Instruments will be your logical choice when victory is won.

SUPREME INSTRUMENTS CORP. GREENWOOD, MISSISSIPPI

OPPORTUNITY AD-LETS

Advertisements in this section cost 10 cents a word for each insertion. Name, address and initials must be included at the above rate. Cash should accompany all classified advertisements unless placed by an accredited advertising agency. No advertisement for less than ten words accepted. Ten percent discount six issues, twenty percent for twelve issues. Objectionable or misleading advertisements not accepted. Advertisements for April, 1943, issue must reach us not later than March 10, 1943.

Radio-Craft • 25 W. B'way • New York, N. Y.

RADIO SERVICEMEN AND EXPERIMENTERS SEND for our giant radio catalogue. Save dollars. United Radio Co., (1000P) Newark, N. J.

BURNED OUT RADIO TRANSFORMERS CAN BE salvaged. We rewind all types of transformers. Write for list. Transformer Rewinding Service, 1302 West Hill, Valdosta, Georgia.

PATENTS — TRADE MARKS

Booklet concerning Inventions & Patents Form "Evidence of Conception" with instructions for use and "Schedule of Government and Attorneys Fees"—FRED LANCASTER, ALLWINE & ROMMEL Registered Patent Attorneys 436 Bowen Bldg. Washington, D. C.

Inventions Wanted Patented or Unpatented

We have been successfully selling inventions, patented and unpatented, since 1924. Write us, if you have a practical, useful idea for sale.

CHARTERED INSTITUTE of AMERICAN INVENTORS

Dept. 109 Barrister Building, Washington, D. C.

WANTED

Crosley Chattabox
Intercommunication
Systems

State in what condition and name your lowest price.

We will pay express charges.

HENRY BURK

350 Greenwich St.,
New York City

Diagrams for

THE RADIO EXPERIMENTER

If you have a new Hook-Up, send it along; a pencil diagram will do. Be sure to include a brief description.

All diagrams and descriptions accepted and published will be awarded a year's subscription. Diagrams may be for receivers, adapters, amplifiers, etc. Send them to Hook-Up Editor, RADIO-CRAFT, 25 W. Broadway, New York City.

T.R.F. RECEIVER FROM JUNK PARTS

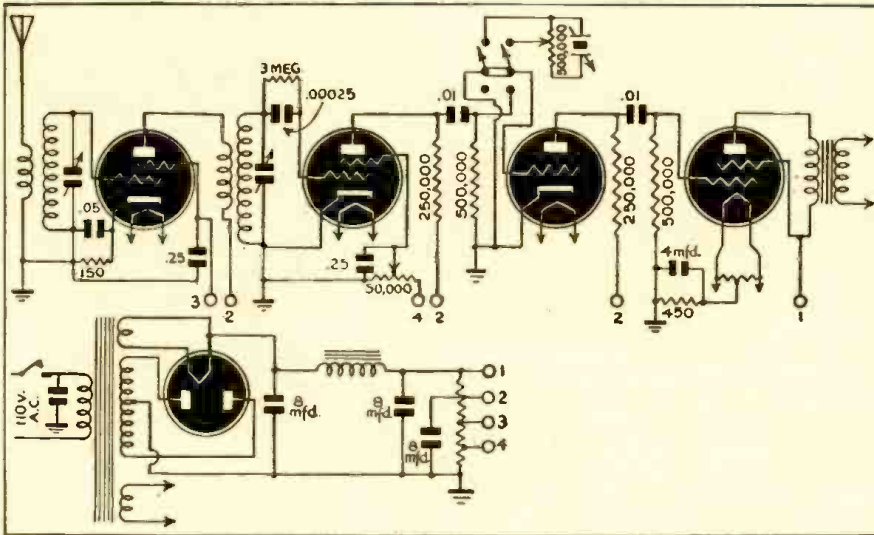

The circuit diagram shows a four-tube T.R.F. set for operation on A.C. only, which I built from salvage parts obtained from about four or five old sets.

The coils are hand wound on 1½-inch diameter forms. The primary contains 20 turns and the secondary approximately 100 turns, depending upon the tuning condensers used. The ones I used were about .00035 mfd.

By using two separate condensers instead of one ganged unit, better and sharper tuning can be obtained.

There is no special layout of parts because different builders may have different sized components.

The person making this receiver must make sure that the output transformer matches the type 47 output tube, otherwise distortion will result.

Any suitable antenna of at least 50 feet can be used.

BENJAMIN J. WOLFF,
Fort Monmouth, N. J.

ONE-TUBE A.C. — D.C. RECEIVER

This one-tube receiver uses a 6C8G tube, and will operate directly from the 110-V. line, A.C. or D.C.

The diagram is quite simple. All parts may be found in the junk box.

The coil data may have to be changed slightly to give the desired coverage. The coils were wound on tube bases (4 prong) and 4-prong coil forms, 1½ inch in diameter.

The set is a simple regenerative detector, using one triode of the 6C8G tube, and a half-wave rectifier using the other triode section as a diode.

Regeneration is controlled by a 15,000 ohm potentiometer.

This set has pulled in signals from all over the world. The best DX was KC4USB at Little America. It should prove a very

good all-wave receiver in any shack.

The coils must be wired properly for correct operation. If the set fails to regenerate, reverse the leads to L2, the tickler.

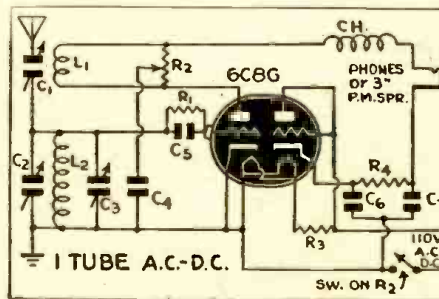

Parts List

CONDENSERS

- C1—3-35 mmf. trimmer
- C2—140 mmf. variable (band setting)
- C3—15 or 20 mmf. variable (band spread)
- C4—.0005 mfd. mica
- C5—.0001 mfd. mica
- C6—12 mfd. filter condenser
- C7—16 mfd. filter condenser

RESISTORS

- R1—3 meg., ¼ W.
- R2—15,000 potentiometer with switch
- R3—390 ohm (in line cord)
- R4—20,000, 1 W.

MISCELLANEOUS

- CH1—2.1 or 2.5 mh., r.f. choke

COIL DATA (No. 28 wire, enameled)

	L2	L1
200—500 Meters	90 T.	35 T.
100—200 "	50 T.	15 T.
50—100 "	20 T.	8 T.
25—50 "	8 T.	5 T.
15—25 "	4 T.	3 T.

(spaced to occupy ¾ inches)

LEO SILBER,
Springfield, Mass.

TWO CHANNEL MIXER PRE-AMPLIFIER

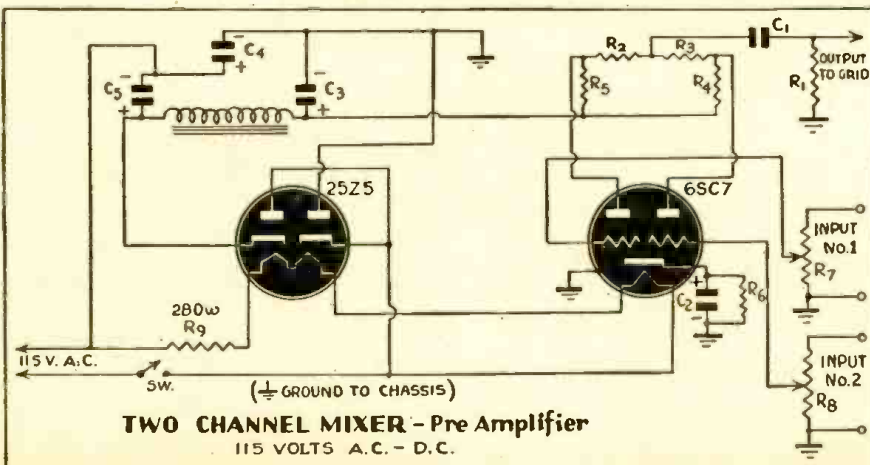

This diagram shows a self-powered, high gain, two-channel mixer pre-amplifier. It uses a 25Z5 and a 6SC7 in an A.C.-D.C. circuit.

A crystal mike and a phono pickup can be mixed or faded at will into a radio or amplifier. Be sure to disconnect the ground from the radio or amplifier as this is an A.C.-D.C. job!

This unit makes it possible to use a high quality mike with a radio, as it increases the gain of the amplifier considerably.

Parts List

RESISTORS

- R1, R2, R3—1 meg., ½ Watt
- R4, R5—250,000 ohms, ½ Watt
- R6—2,000 ohms, ½ Watt
- R7, R8—1 meg., potentiometer

(Continued on following page)

CONDENSERS

C1—8 mfd., electrolytic, 50 V.
 C2—.05 mfd., by-pass, 200 V.
 C3, C4, C5—24 mfd., electrolytic, 300 V.

MISCELLANEOUS

Ch.—10 henry, 400 ohms resistance, 30-40 mills
 R9—290 ohm line cord
 Tubes—26Z5, 6SC7

OTTO POLLEI, JR.
 Louisville, Ky.

R.C. AND E. TESTER

THIS is an original resistor, condenser and voltage tester which incorporates A.C. and D.C. continuity on a single 0-1 milliammeter which is of the D.C. type.

The model I built was made in a box 6 by 4 by 8 inches. I used a 5W4 instead of the 80 as it was shorter.

The meter for the resistor checker may

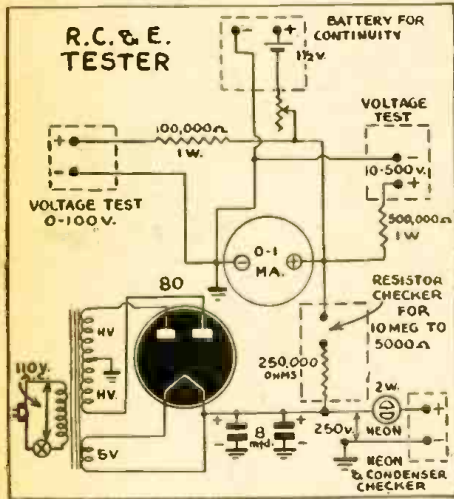

be calibrated in this way. Get several good resistors and find out their reading on the meter and fill in the rest by mathematics. My power transformer was 2½ by 4 inches. The neon bulb is of the 2-watt type as all others will burn out.

The 250,000 limiting resistor is based on 250 volts being available. Caution must be observed here if the voltage is higher, to see to it that more than 250,000 ohms be inserted, in order to limit the current flow to 1 mil. Otherwise the meter may be burned out quite suddenly.

In fact it might be advisable to use 500,000 ohms variable, and adjust till the needle on the meter indicates full scale.

This is a very versatile and accurate meter and will be found to be very useful.

SAM GLASS
 Atlanta, Georgia.

GET ON THE TECHNICAL FRONT

of U. S. Govt. or Civilian Service

Whether you go into military service or remain in Civilian ranks, radio offers you the big opportunity for bigger pay, rapid promotion and substantial positions during and after the war. Radio Technicians are needed everywhere. You don't have to give up your present job to start Radio Training. National Schools of Los Angeles has developed a home plan of practical Radio Training to fit your needs, regardless of your age, education or draft status.



BE A RADIO TECHNICIAN

"TRAINED MEN NEEDED"

cry the Want Ad Columns of every newspaper, in every city. That's proof of the need today! And after the war, too. Trained Radio Technicians will continue to be in demand, with permanent jobs.

FREE SAMPLE LESSON & BIG OPPORTUNITY BOOK

So that you can self-demonstrate your ability to learn Radio by National's Tested Plan we will send one Free Demonstration Lesson and Book of Radio Information. Mail the Coupon today.

Men of all ages can qualify



FREE LESSON & OPPORTUNITY BOOK

Special Offer No obligation

USE THIS COUPON

Take your place as Radio Technician in America's Victory Program NOW; also be ready for continued advancement in industrial rebuilding when the War is over.

QUALIFY FOR THESE JOBS

- RADIO EXPERT AIRCRAFT
- BROADCASTING MARINE
- INDUST. ELECTRONICS
- GOV'T STUDIO TECHNICIAN
- SERVICE REMANUFACTURE

SHOP METHOD HOME TRAINING



Every phase of your Home Training is supervised by experienced Radio instructors and engineers, based on actual shop practice. National Graduates are qualified for good jobs in studios, shops, plants, laboratories, afield in action, to repair, operate, install and supervise Radio in all its branches.

NATIONAL SCHOOLS

Los Angeles California
 ESTABLISHED 1905



MAIL OPPORTUNITY COUPON FOR QUICK ACTION

National Schools, Dept. RC-3
 4000 S. Figueroa, Los Angeles, Calif. (Mail in envelope or paste on penny postcard.)

MAIL me FREE, without obligation, one Lesson and Opportunity Book, with full details about how I can become a Radio Technician.

NAME _____ AGE _____
 ADDRESS _____
 CITY _____ STATE _____

AN INEXPENSIVE P.A. AMPLIFIER

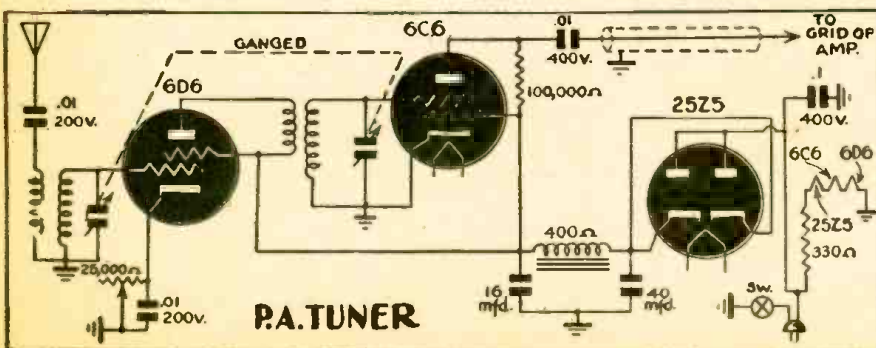

SOMETIMES a simple R.F. tuner is needed to bring in just a few of the powerful local stations, to be operated through a small public address system. Almost anything will do, as a rule.

The P.A. tuner shown in the circuit diagram gives a very fine quality tone when used with a good amplifier, having an 8-inch speaker, or better still a 12-inch speaker.

Most of the parts were obtained from old receivers. The chassis came from an old A.C.-D.C. set. The coils were matched by taking them from the same old A.C.-D.C. set.

DICK JUDKINS
 Chicago, Illinois.

NEW RADIO-CRAFT LIBRARY BOOKS



THE four latest books of our well-known RADIO-CRAFT Red Books—Nos. 25, 26, 27 and 28—recently published. These four books are all on timely subjects and we recommend every one of them to you strongly.

Now, more than ever, radio education has become a burning question. If you are to be in the National Service in the Army, Navy or Air Force, practical radio knowledge is of paramount importance. **YOU CAN GET BETTER RATINGS AND ADVANCE QUICKER IF YOU HAVE A GOOD RADIO BACKGROUND.**

Conversely, if you are not with the armed forces, there is a whole of a job to be done at home. With more and more men going into the service, the demand for practical servicemen becomes greater each day. Therefore we say: **PROFIT BY THESE UNIQUE BOOKS, WHICH ARE PRICED SO LOW THAT THEY ARE WITHIN THE REACH OF EVERYONE'S PURSE.**

No. 25—HOME-MADE RADIO TEST INSTRUMENTS

This book includes articles covering a wide range of test apparatus of live interest to every radio man. Servicemen will find many circuits in this book to make their work more profitable. New ideas in test equipment make it possible to service radio receivers more quickly.

Laboratory workers and experimenters will find many articles which describe in detail construction and use of all essential radio test units—multi-meters, oscillators, stage-analysis testers, oscilloscope equipment, V.-T. voltmeters, etc. Even advanced technicians will be interested in the circuit arrangements showing the new and improved variations of well-known, basic test equipment. A MUST for every serviceman. This book contains 86 illustrations.

Outline of Contents: A Low-Cost Signal Chaser—Signal Tracer Test Unit—Simplified Practical Signal Tracer—A Home-Made Infinite-Resistance Tube Checker—Build This Direct-Reading V.-T. Voltmeter—How to Make a Modern V.-T. Voltmeter—Measuring High Values of A.C. Voltage and Current with a Low-Range Meter—How to Make a Meter-Range Extender—How to Build a Practical Tube Tester and Set Analyzer Adapter—The Beginners' Simple Volt-Milliammeter—Build This Simplified Neon-Type Test Unit—Midsize Oscilloscope—How to Make and Use a Frequency Wobbler—Double Tracing Your Oscilloscope—Home-Made Frequency Modulator.

No. 26—MODERN BATTERY RADIO SETS

Whether you are a radio man or a beginner, the articles in this book give you basic circuit arrangements or elementary radio receivers which serve the dual role of teaching the elements of radio reception, as well as making perfectly operating 1- and 2-tube radio receivers. Picture diagrams and bread-board layouts follow.

Advanced radio set builders are offered more complicated arrangements. Laboratory workers and engineers will find in many of the articles circuit and constructional features which have become commercial practice. Many entirely new ideas are given in this book. One of the most important volumes we recently issued. This book contains 76 illustrations.

Outline of Contents: Beginner's 1-Tube High-Gain All-Wave Receiver—Beginners-Build This 1-Tube Loop Receiver—A "3-in-1" Battery Portable—An Easily-Built "Flewelling Superregenerative" 2-in-1 "Card File" Battery Set—A 2-Tube Superhet. With Pentagrid Regenerative 2nd-Detector—The 4-Tube Superhet. Vacation Portable—The "Lunchbox 5" Battery Portable—"The Seafarer" Loop-Type Best Radio Set—A Tube Permeability Portable—An All-Purpose Portable—A Typical Commercial 3-Way Portable (Pilot Models X-1452 and X-1453)—Switch for Varying "C" Bias on Battery Radio Sets—Making a Simple Portable Aerial—Making a Pilot-Light Fuse—Old Auto Sets for New Cars—Using a Loop Portable in Cars—Quasi-Electric Soldering Iron—Lamp Bulbs as Resistors.

No. 27—MODERN RADIO SERVICING TECHNIQUE

Here is a book of great importance to every radio man, every radio engineer, and particularly all radio servicemen. A list of the contents which follows shows the importance of this book, literally jam-packed to overflowing with radio meat. Whether you are a servicing beginner or whether you are an experienced serviceman—you will find many important helps in this volume. Book is eminently practical and will solve many problems for you. More important: it will show you many short-cuts, all calculated to save your time and patience. Practical everyday data on standard receivers appears throughout the book. A whole of a book compressed into a minimum of space. Contains 98 important illustrations.

Outline of Contents: Elementary Servicing Technique—Correct Procedure for the Servicing Beginner—Elementary Procedure for Servicing Radio Sets—A.F.C. Alignment Made Easy—Dynamic Servicing—Dynamic Testing Simplified Servicing—Modern Receiver Test Requirements—Servicing Universal A.C.-D.C. Receivers—Servicing "Orphans" and Private-Brand Sets—Emergency Servicing Without Test Meters—Servicing Coils—Servicing R.F. Coils—Servicing Oscillator Coils—General Information—RMA Transformer Color Code—What Causes Echo, Fading?—Radio Service Puzzlers.

No. 28—ALL ABOUT FREQUENCY MODULATION

Here is a complete compilation of pertinent data on the entire subject of the new coming art of Frequency Modulation.

There is no question but that Frequency Modulation is already revolutionizing radio broadcasting in this country. Were it not for the war, there would now be a tremendous boom in this new art—yet, even with war restrictions imposed upon it, Frequency Modulation is still jumping ahead by leaps and bounds.

With Frequency Modulation no longer a theory—with hundreds of stations already dotting the land and with countless hundreds of others to come when peace is achieved once more—every radio man should read up and know all there is to know on this most important subject.

This particular handbook is chock-full with a tremendous amount of information which you probably will not find in any similar book in print.

Outline of Contents: The ABC of F.M.—Frequency vs. Amplitude Modulation—Basic Facts About F.M. Broadcasting—Construction—Build This Practical F.M. Adapter—Audio Amplification—F.M. Audio Amplifier, Part 1—F.M. Audio Amplifier, Part 2—F.M. Audio Amplifier, Part 3—F.M. Service—Part 1, Antenna Installation and Service—Part 2, Receiver Alignment and Diagnosis—Part 3, Test Equipment for F.M. Servicing, Engineering—Part 4, The How and Why of F.M.—Part 2, The How and Why of F.M.—Theory and Design Considerations of R.F. and I.F. Coils in F.M. Receivers.

SPECIAL SEND-NO-MONEY OFFER

It is not necessary that you send money with order. If you wish to take advantage of our C.O.D. plan, simply cut out the coupon, paste it on a post card and send it to us. Books will be sent to you immediately.

All four books are listed uniformly at 50c each. No discount on less than three books.

If you wish to take advantage of our special offer, ordering three books or more, we make an unusual low price to you as follows:

3 books—\$1.25
4 books—\$1.50

Do not fail to send coupon today!

RADIO-CRAFT PUBLICATIONS, INC.
25 West Broadway, New York, N. Y.

RADIO-CRAFT PUBLICATIONS, INC.		343
25 West Broadway, New York, N. Y.		
Gentlemen:		
Rush to me by return mail, as per your special offer, the following books: (Check books selected.)		
<input type="checkbox"/>	No. 25—HOME-MADE RADIO TEST INSTRUMENTS.	
<input type="checkbox"/>	No. 26—MODERN BATTERY RADIO SETS.	
<input type="checkbox"/>	No. 27—MODERN RADIO SERVICING TECHNIQUE.	
<input type="checkbox"/>	No. 28—ALL ABOUT FREQUENCY MODULATION.	
I will pay postman \$1.00 (if two books are ordered) plus a few cents postage and charges, \$1.25 for three books, plus a few cents postage and charges, \$1.50 for four books, plus a few cents postage and charges. WE CANNOT SEND A SINGLE 50c BOOK C.O.D.		
NAME		PLEASE PRINT CLEARLY
ADDRESS		
CITY	STATE	
<input type="checkbox"/> Save shipping and C.O.D. charges! Check here if you send cash with order. (Cash, U.S. new postage stamps, money order, check.) Foreign countries no C.O.D. Add 20% to all prices quoted.		

BUZZER BURNOUT PREVENTER

Following is a kink which I have found to be very useful.

I noticed that the points of my high frequency buzzer were gradually being burned and also that the tone of the note was varying.

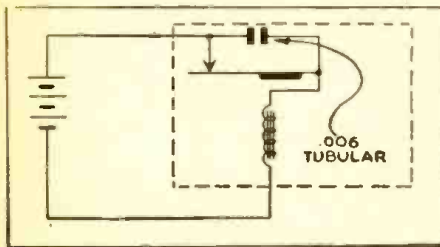

I took a .006 mfd. tubular condenser and connected it across the two points.

This immediately steadied the note, and stopped the sparking.

KENNETH L. POSEY,
Sioux City, Iowa.

(We used this stunt back in the old wireless days. It's rediscovered by the new generation every so often—yet it's always good.—Editor)

SIMPLE VOLT-OHM MILLIAMETER

This simple volt-ohm milliammeter can be easily constructed, and mounted in a portable case if desired.

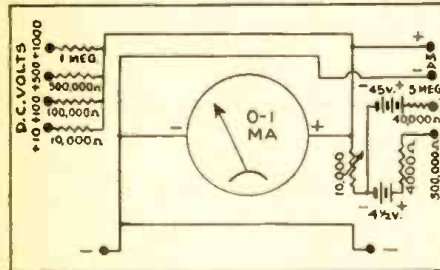

The meter is of the "Universal" type, which can be purchased quite reasonably from almost any radio mail-order supply house. The resistors, for the average experimenter, need not be expensive, as extreme accuracy will not be demanded.

The meter and tip jacks may be mounted in a bakelite panel, and the whole unit complete with batteries, may be mounted in a wooden case.

The 4½ volt and 45 volt batteries may also be mounted in the case, for portability.

H. J. ARNOLD,
Marshalltown, Iowa.

New Tube Manual

THE 5th edition of the Sylvania Technical Manual is now ready for distribution to Radio Technicians.

One section is devoted to listing all new types of tubes released since the previous issue, and a section pertaining to panel lamps has been added.

Plastic binding has been employed, which allows the book to lie flat and remain open at whatever page is to be consulted.

The general arrangement of the technical data of the reprinted Manual remains the same, and index tabs are still supplied, glued and marked for easy installation on the proper pages.

The Manual sells for the pre-war price of 35c per copy, and may be secured from your distributor or direct from the publishers of Radio-Craft.

Lowest Priced Publications for Experimenters

10 FOR 50c

Here is a large number of radio, short-wave, and mechanical "how-to-make-it" designs. Each is a special publication originated by masters in their respective fields. For the low price of 50 CENTS, you buy TEN complete pamphlets with photographic reproductions, complete mechanical layout, and full description to make it possible for anyone to build the project in question.

PLEASE ORDER EACH PROJECT BY ITS PUBLICATION NUMBER, and use the special coupon below. We accept money-orders, cash, checks or new U. S. stamps. (No foreign stamps.) If you send cash or stamps, register your letter. Money refunded if you are not satisfied. ANY TWENTY-FOUR PUBLICATIONS FOR ONE DOLLAR.

SHORT-WAVE RECEIVER PUBLICATIONS

- HOW TO MAKE THE "OSCILLODYNE" I TUBE WONDER SET.....No. 101
- HOW TO MAKE THE "19" TWIN- PLEX (ONE TUBE PERFORMS AS TWO) RECEIVER.....No. 102
- HOW TO MAKE THE WIZARD, I- TUBE 50-WATT TRANSMITTER.....No. 103
- HOW TO MAKE THE IMPROVED 3-TUBE DOERLE SET FOR BATTERY OPERATION.....No. 104
- HOW TO MAKE THE "GO-GET- 'EM 2" RECEIVER FOR THE BE- GINNER.....No. 105
- HOW TO MAKE THE I-TUBE- ALL-ELECTRIC OSCILLODYNE.....No. 106
- HOW TO MAKE THE 2 TO 5 METER TWO-TUBE LOUDSPEAK- ER SET.....No. 107
- HOW TO MAKE THE 3-TUBE BATTERY SHORT-WAVE RECEIV- ER.....No. 108
- THE BRIEF-CASE SHORT-WAVE RECEIVER AND HOW TO BUILD IT.....No. 109
- HOW TO BUILD THE POCKET SHORT-WAVE RECEIVER.....No. 110
- HOW TO BUILD THE CIGAR- BOX I-TUBE "CATCH ALL" RE- CEIVER.....No. 111
- HOW TO BUILD THE "DUAL- WAVE" SHORT-WAVE BATTERY RECEIVER.....No. 112
- HOW TO BUILD THE I-TUBE "53" TWINPLEX" RECEIVER.....No. 113
- HOW TO BUILD THE PORTABLE MINIDYNE SHORT-WAVE BATTERY SET.....No. 114
- HOW TO BUILD THE HAM-BAND "PEE-WEE" 2-TUBER.....No. 115
- HOW TO BUILD THE DUO-AM- PLIDYNE.....No. 116
- HOW TO BUILD THE "MONO- COIL 2".....No. 117

RADIO BROADCAST RECEIVER AND SPECIAL RADIO PUBLICATIONS

- HOW TO MAKE THE A.C.-D.C. "CASH BOX" RECEIVER No. 118
- HOW TO MAKE BEGINNER'S 2- TUBE ALL-WAVE SET.....No. 119
- HOW TO BUILD THE "RADIO- LAMP" 4-TUBE TABLE RECEIV- ER.....No. 120
- HOW TO BUILD A SUPER-SEN- SITIVE ALL-WAVE CRYSTAL SET.....No. 121
- HOW TO BUILD THE 2-TUBE "PENTODE PORTABLE" BROAD- CAST SET.....No. 122
- HOW TO BUILD THE RADIO "TREASURE" FINDER.....No. 123
- HOW TO BUILD THE GERN- SBACK ONE-TUBE PENTODE LOUDSPEAKER SET.....No. 124
- HOW TO BUILD THE WORLD'S SMALLEST ONE TUBE BATTERY RADIO.....No. 125
- HOW TO BUILD A 6-TUBE BATTERY ALL-WAVE "FARM PORT- ABLE" SET.....No. 126
- HOW TO MAKE AN A.C.-D.C. ONE-TUBE "DEAF AID".....No. 127
- HOW TO BUILD A PIANOTRON.....No. 128
- HOW TO BUILD THE ONE-DOL- LAR RADIO.....No. 129
- HOW TO MAKE A VARIABLE- TONE CODE PRACTICE SET.....No. 130

MECHANICAL PROJECTS PUBLICATIONS

- HOW TO MAKE A SOUTH SEA OUTRIGGER CANOE.....No. 131
- HOW TO BUILD A PEE-WEE AUTOMOBILE.....No. 132
- HOW TO BUILD A DUAL-CON- TROL GLIDER.....No. 133
- HOW TO BUILD A HOUSEBOAT ON PONTOONS.....No. 134
- HOW TO MAKE A BAND SAW FROM OLD AUTO PARTS.....No. 135
- HOW TO BUILD A REAL LATHE FOR \$5.00.....No. 136
- HOW TO BUILD A SAIL CAT- BOAT.....No. 137
- HOW TO BUILD A SIMPLE PORT- ABLE REFRIGERATOR.....No. 138
- HOW TO BUILD A XYLOPHONE.....No. 139
- HOW TO BUILD THE ROWMO- BILE.....No. 140
- HOW TO BUILD LARGE TESLA AND OUDIN COILS GIVING 18- INCH SPARKS.....No. 141
- HOW TO MAKE AN ARC WELD- ER.....No. 142
- HOW TO USE AN A.C. ARC WELDER.....No. 143
- HOW TO MAKE YOUR OWN MICROSCOPE.....No. 144
- HOW TO MAKE A WIMSHURST ELECTROSTATIC MACHINE.....No. 145
- HOW TO MAKE A POWER DRILL PRESS FROM SCRAP PARTS.....No. 146
- HOW TO BUILD A GOOD LATHE FOR \$1.00.....No. 147
- HOW TO MAKE AN EXPERI- MENT WITH AN ELECTROPHOR- OUS.....No. 148
- HOW TO MAKE AN ELECTRIC ARC WELDER FROM AN AUTO- MOBILE GENERATOR.....No. 149

RADIO PUBLICATIONS, 25 West Broadway, NEW YORK, N. Y. RC 3

I enclose \$.....for the publications listed by number, at right, at the rate of 50c FOR ANY TEN PUBLICATIONS, NO ORDER FOR LESS THAN 50c ACCEPTED. \$1.00 for 24 publica- tions. These publications are to be sent to me postpaid. I have placed a circle around each number which I want.

PLEASE PRINT CLEARLY

NameAddress

CityState

10 BEST RADIO BOOKS 10 CENTS EACH

- RADIO FANS EVERYWHERE—these fine ten cent text books give you an excellent foundation for the study of RADIO. They are clearly written, profusely illustrated and contain over 15,000 words in each book. You'll be amazed at the wealth of information contained in these handy books. Excellent for reference—ideal for every technical library. YOUR MONEY BACK if you are not satisfied. PROMPT SHIPMENTS
- No. 1—HOW TO BUILD FOUR DOERLE SHORT WAVE SETS
 - No. 2—HOW TO MAKE THE MOST POPULAR ALL-WAVE 1- AND 2-TUBE RECEIVERS
 - No. 3—ALTERNATING CURRENT FOR BEGINNERS
 - No. 4—ALL ABOUT AERIALS
 - No. 5—BEGINNERS' RADIO DICTIONARY
 - No. 6—HOW TO HAVE FUN WITH RADIO
 - No. 7—HOW TO READ RADIO DIAGRAMS
 - No. 8—RADIO FOR BEGINNERS
 - No. 9—SIMPLE ELECTRICAL EXPERIMENTS
 - No. 10—TELEVISION

BOOKS ARE ALL UNIFORM

Every book in the GERNSBACK EDUCATIONAL LIBRARY has 32 pages—with illustrations varying from 30 to 66 in number. Each title volume contains over 15,000 words. Positively radio's greatest book buys! If you do not think these books worth the price asked, return them in 24 hours and your money will be instantly refunded.

RADIO PUBLICATIONS • 25 WEST BROADWAY • NEW YORK, N. Y.

RADIO PUBLICATIONS, Dept. RC-343
25 WEST BROADWAY, NEW YORK, N. Y.

Gentlemen: Please send immediately, POSTPAID, the book numbers circled below. I am enclosing cents —each book being 10c.

1 2 3 4 5 6 7 8 9 10
NEW NEW

Send FREE listing of 48 new 10c publications.

PLEASE PRINT CLEARLY

NameAddress

CityState

Remit by check or money order—register letter if you send cash or unused U. S. postage stamps.

MAIL COUPON TODAY!

RADIO KINKS.

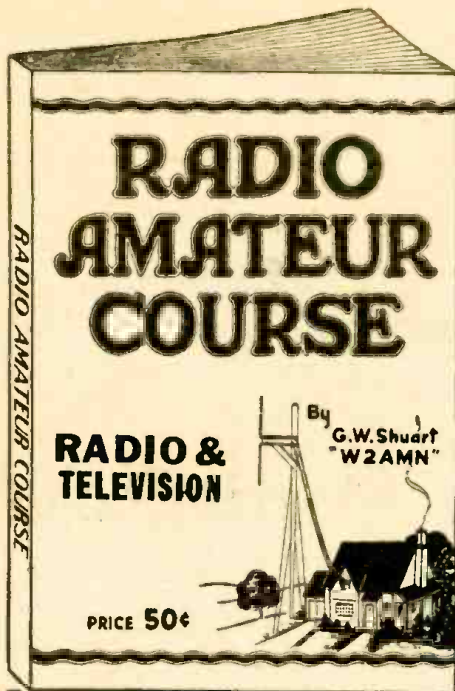

RADIO AMATEUR COURSE

RADIO & TELEVISION

By G.W. Shuart
"W2AMN"

PRICE 50c

148 PAGES

6 x 9 INCHES

OVER 150 RADIO DIAGRAMS
and TECHNICAL PHOTOGRAPHS

RADIO AND TELEVISION

25 West Broadway New York, N. Y.

Your Money Back —
If the RADIO AMATEUR COURSE does not represent the greatest book value ever offered to the radio "fans" for **50c**

To convince you that there isn't a better book buy today, the publishers of the RADIO AMATEUR COURSE make the sensational offer of a money-back guarantee on such a low-priced book. Stop in at any of the many dealers handling this book and examine it. See for yourself if the RADIO AMATEUR COURSE isn't just the book you've always wanted.

Printed on the finest coated paper — well illustrated attractive 4-color cover — complete with radio information you must have. It contains a step-by-step program for obtaining a short-wave radio education.

Written by George W. Shuart, W2AMN
foremost short-wave authority

RADIO AND TELEVISION
25 West Broadway, New York, N. Y.

Gentlemen: I enclose herewith my remittance of Fifty Cents (50c) for which please send me POST-PAID, my copy of the RADIO AMATEUR COURSE. (Remit by check or money order; register letter if you send cash or unused U. S. Postage stamps.) PLEASE PRINT CLEARLY

Name

Address

City State RC-3-43

will find broadcast, medium and shortwave stations all coming in on the set.

VAN R. FIELD
Center Moriches, N. Y.

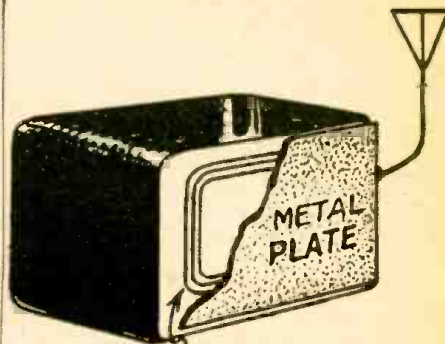

BUILT IN ANTENNA

TEST PROD

The accompanying diagram shows a test prod made of a cord tip and an old



mechanical pencil. Most of us have these odd parts lying about and can make up several, if needed.

One can always make use of more than one pair of prods.

WALLACE CHASE,
Glendale, Calif.

REMAGNETIZING SMALL MAGNETS

This kink is to show how to remagnetize the small magnets in earphones.

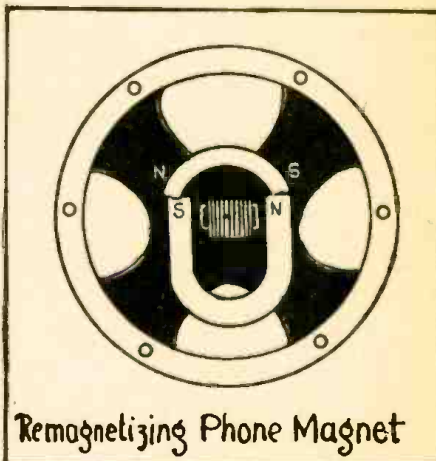

Remagnetizing Phone Magnet

First of all remove the magnets from the phones and place them across the poles of a P.M. speaker and leave them there for approximately a half hour, occasionally giving them a sharp tap with some small object.

I have found that this completely rejuvenates the old earphones which otherwise might be discarded.

WALTER WOYT,
St. Catharines, Ont., Canada.

CIRCUIT CLOSED BY ILLUMINATED LAG RELAY

HERE is an interesting gadget for turning on a radio or other low wattage device by light. It is a lag relay and is operated by the electric lamp used for illuminating the device or room. It can, if desired, be installed to be almost unnoticeable.

BATTERY HOOKUP PRONGS

After building a 1.4-volt set I found I had no battery plug that would fit the irregular holes in the four-prong battery socket. I resorted to the following "kink". I used the prongs from an old five-prong

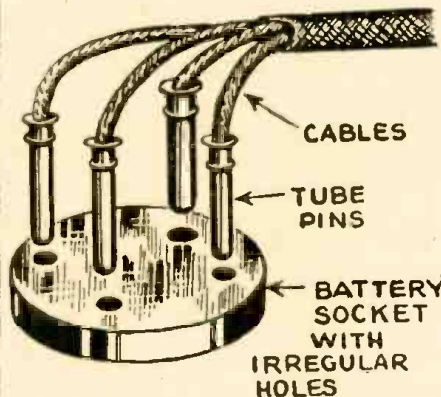

tube base as shown in the diagram. By removing the prongs and soldering the cable wires to them, you will have a flexible plug that will fit the irregular holes in a 1.4-volt battery pack.

H. D. BRAMLETT
Gadsden, Ala.

SHORT WAVE ON BROADCAST

Here is a simple way to get shortwave on a portable or small set of the A.C.-D.C. type.

It must have a built-in antenna. Place a metal plate against the antenna loop winding and put an antenna on the plate. You



"THE INDUCTANCE AUTHORITY"

By EDWARD M. SHIEPE, B.S., M.E.E.

THE ONLY BOOK OF ITS KIND IN THE WORLD, "The Inductance Authority" entirely dispenses with any and all computation for the construction of solenoid coils for tuning with variable or fixed condensers of any capacity, covering from ultra frequencies to the borderline of audio frequencies. All one has to do is to read the charts. Accuracy to 1 per cent may be attained. It is the first time that any system dispensing with calculations and correction factors has been presented.

There are thirty-eight charts, of which thirty-six cover the numbers of turns and inductive results for the various wire sizes used in commercial practice (Nos. 14 to 32), as well as the different types of covering (single silk, cotton-double silk, double cotton and enamel) and diameters of $\frac{1}{4}$, $\frac{1}{8}$, 1, $1\frac{1}{4}$, $1\frac{1}{2}$, $1\frac{3}{4}$, 2, $2\frac{1}{4}$, $2\frac{1}{2}$, $2\frac{3}{4}$ and 3 inches.

Each turns chart for a given wire has a separate curve for each of the thirteen form diameters.

The book contains all the necessary information to give the final word on coil construction to service men engaged in replacement work, home experimenters, short-wave enthusiasts, amateurs, engineers, teachers, students, etc.

There are ten pages of textual discussion by Mr. Shiepe, graduate of the Massachusetts Institute of Technology and of the Polytechnic Institute of Brooklyn, in which the considerations for accuracy in attaining inductive values are set forth.

The book has a flexible fiber cover, the page size is 9 x 12 inches and the legibility of all curves (black lines on white field) is excellent.

Order from your dealer or direct—\$2.50

GOLD SHIELD PRODUCTS

350 Greenwich St., (Dept. R.C.3), New York City

Rivet together a strip of hard rubber and a strip of light weight sheet iron as illustrated. Mount the double strip at one end of a suitable base. Arrange a contact point at the free end of the strips that will make electrical contact with a circuit point as shown. Arrange the illuminating lamp near the strip so it will receive heat from the lamp. This must be determined by experimentation.

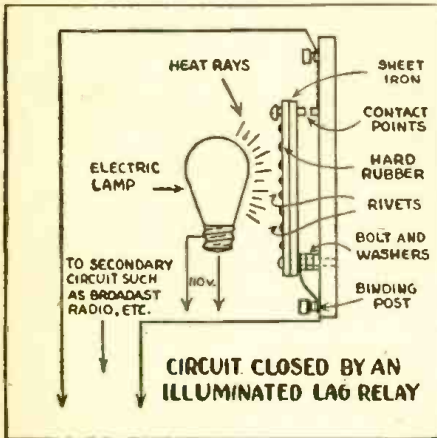

When the lamp is turned on it will be a matter of seconds before the heat from the lamp causes the strip of sheet iron to bend from its expansion. This causes the two contact points to touch and thus complete the secondary circuit. Its application is shown in the diagrams.—L. B. ROBBINS

A JIFFY SOLDERING IRON HOLDER

A jiffy soldering iron holder can be made from a spool such as magnet wire or wire solder usually comes on.

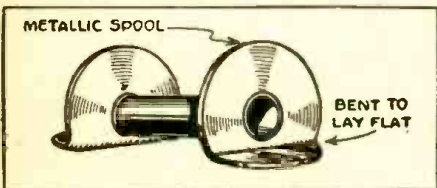

Just simply bend the ends of the spool as shown in the sketch so that it lies flat on the table and supports the iron, and keeps it from sliding or rolling.

B. BERNSTEIN,
New York, N. Y.

(An oldie, but still good—Editor)

HOME-MADE PORTABLE SUBSTITUTION BOX

I believe this portable substitution box is very useful, especially for wartime work in the field or in the laboratory for fast test-

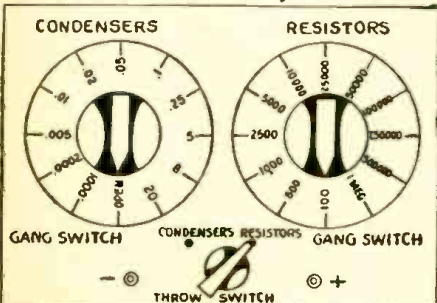

ing, or for correct resistance and correct condensers.

I use this as much as any instrument I have and find it very fast, capable and correct.

CHARLES E. LEWIS,
E. St. Louis, Illinois

HARRISON HAS IT!

Echophone

COMMUNICATIONS RECEIVERS



MODEL EC-2

- Model EC-2 \$42.50
- Model EC-3 59.50
- Model EC-1 24.50

HALLICRAFTERS

- Sky Buddy S-19R \$32.50
- Sky Champion S-20R 54.50

Orders for these receivers should carry a priority rating of AA-4, or better. Not available for individual civilian use. Apply at your local War Production Board.

CODE PRACTICE SET

Buzzer and key, heavily nickel plated, of single unit construction, mounted on wood base. Adjustable high frequency pitch. Complete with silk covered cord, in attractive box with code chart on cover. Works on one or two flashlight or dry cells.

Postpaid—\$2.45

6L6G TUBES

First grade, meter tested, fully guaranteed.

Postpaid—\$1.37 each

(Three for \$3.75—postpaid)

P. M. DYNAMIC SPEAKERS

5 inch, with output transformer to match single plate of 8000 ohms \$1.95

Magnavox, 10 inch. 16 ounce magnet! 6 ohm voice coil \$5.25 (Not postpaid)

Immediate delivery of the above items, without priority, while quantities last. SEND REMITTANCE WITH ORDER. TODAY! (Money back if not satisfied.)

HARRISON
RADIO CORPORATION

11 WEST BROADWAY

NEW YORK CITY

TINNING SOLDERING IRONS

Amateurs, experimenters or set builders are often confronted with a deteriorated soldering iron and no sal ammoniac on hand.

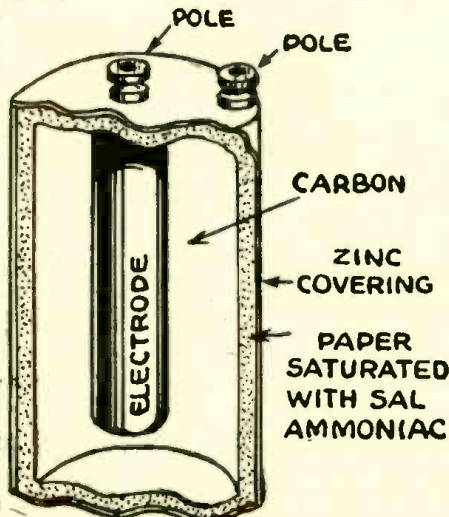

All you have to do is to secure one or two 1½ volt dry cells, large size (see drawing).

Split the battery from top to bottom, and also cut off the bottom piece.

Empty out the carbon mix and remove the center electrode. Peel off the paper from the zinc.

Enough sal ammoniac will be found between the layers of the paper and on the inside part of the zinc to tin the soldering iron hundreds of times.

ALTON J. LARPENTEUR,
Franklin, Louisiana.

LAWRENCE SLIDE RULES

With A, B, C, D, CI and K Scales

FEATURES: Nickel Silver Framed Indicator with integral friction springs.

Scales calibrated directly on well seasoned wood. Will retain accuracy regardless of temperature or humidity changes.

Instructions and illustrations of primary operations clearly printed on back of rule for ready reference or teaching. Each rule in a durable pocket carrying case for convenience and protection.

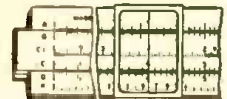

The extremely low price of these slide rules and their absolute accuracy makes them ideal for the student as well as the working man who has always wanted to learn to use a slide rule.

- LAWRENCE 10 inch white-enamelled slide rule with flat magnifier, in black case. Price, including 28-page instruction book No. 457.. 60c
- Secret Code Slide Rule, with 20-page book No. 458.. 30c (2 for 50c)
- 28-page illustrated book of instructions, postpaid No. 459.. 15c

GOLD SHIELD PRODUCTS

350 Greenwich St. (Dept. RC3) New York City

Headset Headquarters



Folder C-3 illustrates complete line of Guaranteed

CANNON-BALL HEADSETS

Beautifully designed. Light in weight. Efficient. Reproduce with clarity and good volume. Write.

Scientifically built Heavy bar magnets greatly increase their efficiency.

C. F. CANNON COMPANY
SPRINGWATER, N. Y.

WHILE THE LAST

All of the attractive items listed here are brand new. ALL are in PERFECT WORKING ORDER. In many cases, the parts alone total more than the price we are asking. 100% satisfaction guaranteed or your money refunded.
ORDER FROM THIS PAGE. Use the convenient coupon below. Include sufficient extra remittance for parcel post charges, else order shipped express, collect. Any excess will be refunded. C.O.D. shipments require 20% deposit. If full remittance accompanies order, deduct 2% discount. Send money order, certified check, new U. S. stamps. No C.O.D. to foreign countries.

ORDER TODAY LIMITED QUANTITIES PROMPT SHIPMENTS ASSURED

THE SODERWAND SUPER SOLDERING IRON

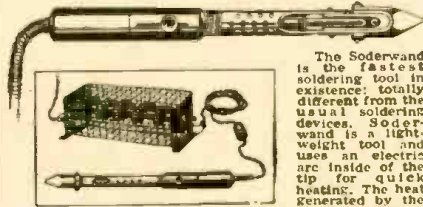

The Soderwand is the fastest soldering tool in existence; totally different from the usual soldering devices. Soderwand is a light-weight tool and uses an electric arc inside of the tip for quick heating. The heat generated by the arc is so intense the copper is hot enough to flow solder. There is a constant surplus of heat which makes quick soldering jobs seem easy. Current consumption is small, as only intermittent current is necessary to keep iron hot. Convenient thumb control cuts current on or off. Simple in design. Burn-out impossible as there is no heating element to burn out.

The Soderwand is an all-purpose tool that takes care of the heaviest or most delicate job with equal ease. **IMPORTANT:** This is a brand new item and comes in its original packing. We acquired the manufacturer's entire stock, which is the reason why we can sell the tool for so little money. **THE ORIGINAL PRICE WAS \$8.00.**

Supplied with regular No. 5 pyramid tips, 14 feet of cord, attachments, plugs, resistance unit, and two extra sets of carbons. Blade for 110 volts A.C. 60 cycles, or D.C. Size: 13" long. Tool weighs 10 oz. Ship. wt. of outfit 4 lbs.
ITEM NO. 154
YOUR PRICE \$3.00

WATCH-CASE MICROPHONE

This mike contains a unit like the famous Skinderviken Button, mounted in a cast-aluminum case resembling a large head-phone unit. 2-inch diaphragm. A push-to-talk is mounted in the case. 200-ohm impedance. Works into any transformer designed for single-button microphones. Operates on one dry cell. Just the thing for home telephone sets, "home broadcasting," use with phonograph oscillators, etc. Case finished in Duco enamel. Slightly used. Size 2 1/2" by 1 1/2". Shipped postpaid.
ITEM NO. 156
YOUR PRICE \$1.00

SENSITIVE RELAY

This relay has back and front contacts, breaking one contact and making another when actuated. 5-ohm coils, sterling silver contacts, 5 binding posts. Relay can be adjusted to trip at 30 milliamps. Invaluable to experimenters. Can be used for remote control of apparatus, as circuit-breaker, etc. Will operate as electronic relay in plate circuit of average power tubes, as in air-raid "alarm" units and other automatic devices. Adjustable hair-spring tenon. Heavy slate-and-iron base 2 3/4" by 3 1/2". All metal parts (except base) in heavy brass. Slightly used, but a first class relay in all respects. Ship. Wt. 3 lbs.
ITEM NO. 155
YOUR PRICE \$1.85

POWERFUL ALL-PURPOSE INDUCTION MOTOR IDEAL FOR EXPERIMENTERS—101 USES

Sturdily constructed to precision standards, this self-starting shaded pole A.C. induction motor is powerful enough for a large variety of uses. Some of these are: Automatic Timing Devices, Current Interrupters, Electric Fans, Electric Chimes, Window Displays, Photocell Control Devices, Electric Vibrators, Small Grinders, Buffers and Polishers, Miniature Pumps, Mechanical Models, Sirens, and other applications.
 Consumes about 15 watts of power and has a speed of 3,000 r.p.m. When geared down, this sturdy unit will constantly operate on an 18-inch turntable loaded with 200 lbs. dead weight—**THAT'S POWER!**
 Dimensions, 3" high by 2" wide by 1 1/2" deep; has 4 convenient mounting studs; shaft is 3/8" long by 3/16" diameter, and runs in self-aligning oil-retaining bearings. Designed for 110-20 volts, 50-60 cycles. A.C. only.
ITEM NO. 147
YOUR PRICE \$1.45

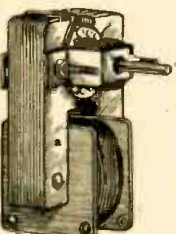

WESTERN ELECTRIC BREAST MIKE

This is a fine light-weight aircraft carbon microphone. It weighs only 1 lb.
 Mike comes with breast-plate mounting and has 2-way swiveling adjustment so that it can be adjusted to any desired position. There are 2 woven straps, one goes around neck, the other around chest. Straps can be snapped on and off quickly by an ingenious arrangement.
 This excellent mike can be adapted for home broadcast or private communication systems. By diamonding breastplate, it can be used as desk mike.
 Comes complete with 6-foot cord and hard rubber plug. Finished in sherdarized plate, non-rustable.
THIS IS A BRAND NEW MIKE. IT HAS NEVER BEEN SOLD AT SUCH A LOW PRICE BEFORE. ORIGINAL LIST PRICE \$3.00. Shipping weight, 2 lbs.
ITEM NO. 152
YOUR PRICE \$2.55

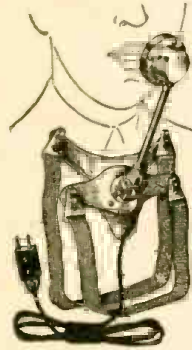

METAL CUTTING SAW

Here is an ideal metal-cutting saw made of fine tool steel specially designed to cut metal. Teeth are set at a special double angle for metal-cutting work. Saw is specially hardened for long and extended use; measures 3 1/4" diameter; center hole is 3/8" square; thickness 12/1000 (42 mils.) 3/64".
ITEM NO. 151
YOUR PRICE 50c



POWER ADJUSTABLE RHEOSTAT

Here is an excellent rheostat used especially to regulate speeds of small motors, such as our Handy Workshop Outfit. This rheostat can be used in connection with motors up to 1/20 h.p.
 This fine rheostat is wire-wound on porcelain insulation. The black enamel steel casing is perforated for ventilation. Adjustable handle regulates speed of motor easily and smoothly. Size 2 1/2" x 3 1/2" overall. Ship. Wt. 2 lbs.
ITEM NO. 153
YOUR PRICE \$1.45



AMAZING BLACK LIGHT!

Powerful 250-Watt Ultra-Violet Source
 The best and most practical source of ultra-violet light for general experimental and entertainment use. Makes all fluorescent substances brilliantly luminescent. No transformers of any kind needed. Fits any standard lamp socket. Made with special filter glass permitting only ultra-violet rays to come through. Brings out beautiful opalescent hues in various types of materials. Swell for amateur parties, plays, etc. to obtain unique lighting effects. Bulb only. Ship. Wt. 1 lb.
ITEM NO. 87
YOUR PRICE \$2.00



WATT HOUR METER

Completely overhauled and ready for immediate service. Designed for regular 110-volt, 60 cycle 2-wire A.C. circuit. Servicemen use it in their shops to check current consumption of sets, soldering irons, etc. Keeps costs down. If dismantled, the parts alone would bring the price. The elaborate gear train could be used as a counter on machines of various kinds. Simple to install; 2 wires from the line and 2 wires to the load. Sturdily constructed in heavy metal case. 8 1/2" high, 6 1/2" wide, 5" deep. Westinghouse, E. or Ft. Wayne makes. Ship. Wt. 14 lbs.
ITEM NO. 33
YOUR PRICE \$4.95



ELECTRONICS—ITS LATEST MIRACLES

(Continued from page 339)

Coal Company of Ohio has been fortified against undue accidents by the installation of a General Electric Company photoelectric relay and light source. At this plant, coal cars are emptied by being rolled onto a rotary dump, fastened to the track rails by a mechanical gadget, and then rolled upside down over the chute. Once the coal car has been put into the right position again, it moves off the dump in accordance with Newton's well-known law of gravity. However, there may be an upset in this orderly plan should the dump revolve a full car before the preceding empty one has moved off. The empty car sprawls onto the floor. This unhappy action has happened.

But now, with an "electric eye" and a beam of light, installed on opposite sides of the railroad track at the "empty" end of the dump, a threatening shadow casts its form as a warning signal. In other words, the dump is unable to revolve as long as the beam of light between its source and the phototube in the relay is blacked out by the body of the empty coal-car.

AN ELECTRONIC MOISTURE DETECTOR

We usually think of hygrometers as moisture indicators, but this function is no longer delegated exclusively to that type of instrument. Westinghouse has designed an electronic moisture detector, especially adaptable to the war-time job of manufacturing rust-free steel parts for gun, planes, and tanks. This and similar material is hardened by heat in an airless gas atmosphere, such as hydrogen. This insures a highly polished surface, immune to scale and rust. However, the presence of a small amount of water vapor during the steel-hardening process would mean rust.

Heretofore human beings have acted as moisture detectives, spending considerable time at inspections. Now instantaneous detections are possible. A two-element tube, not unlike a radio rectifier, has an inlet and outlet, through which courses the gas, on its way to the steel furnace. So long as dry gas passes through, these miracle-performing tiny electrons from the radio tube's hot filament to the plate flow steadily, creating an electric current without variations. If, however, water vapor is present, some of the electrons fasten themselves to the atoms of the water's oxygen. This behavior acts instantly in reducing the flow of electric current. These fluctuations may be translated into terms of moisture by a simple meter, or may be registered on an elaborate recording instrument. This same robot-like moisture detector may be commissioned to the role of sleuthing for and measuring impurities in certain industrial gases.

DETECTS 2,000,000 SHADES OF COLOR

If experiments now in progress at the Materials Laboratory of the United States Army Air Forces, Dayton, Ohio, prove successful colored chips or samples may be discarded as means of standardizing colors. Instead, an electronic instrument will be introduced, with its uncanny ability to distinguish 2,000,000 shades of color. Chips or samples fade under different temperature conditions and methods of handling, we are told, and therefore cannot be relied upon absolutely.

The photoelectric spectrophotometer, however, which is so much more reliable, is now being employed in standardizing camouflage colors, color characteristics of luminescent material, and in the measurement of light transmission and reflection of

HUDSON SPECIALTIES CO., 40 West Broadway, N. Y. C.

IT'S EASY TO ORDER—CLIP COUPON—MAIL NOW ORDER FROM THIS PAGE.

HUDSON SPECIALTIES CO., 40 West Broadway, Dept. RC-3-43, New York, N. Y.
 I have circled below the numbers of the items I'm ordering. My full remittance of \$..... (Include shipping charges) is enclosed. **NO C.O.D. ORDERS UNLESS ACCOMPANIED WITH A DEPOSIT.**
 OR my deposit of \$..... is enclosed (20% required). ship order C.O.D. for balance. No C.O.D. order for less than \$2.00. (New U. S. stamps, check or money order accepted.)
 Circle Item No. wanted: 33 87 147 151 152 153 154 155 156

Name Address

City State

Send remittance by check, stamps or money order; register letter if you send cash or stamps.

transparent plastics. Color curves, for instance, are being obtained on plastics used in airplane windows or turrets, both before and after the material has been subjected to the exposure of Florida sunshine, or accelerated weathering tests, under artificial conditions.

ELECTRONIC SPOT WELDING

An invention of John W. Dawson of Westinghouse provides a common D.C. timing control circuit, electrically connected and operating with discharge devices, for electronic spot-welding. All A.C. voltage components are eliminated save the added phase-shift component. This system of welding has a control electrode in a discharge device, with a potential controlling both the timing and the heat for the welding process. Electronic spot-welding is virtually standard procedure in American aircraft factories.

"MEMORIZING" AND "FORGETTING" ELECTRONICALLY

Aimed at remedying distortion in television images attributable to electrical interference, a circuit designed by the R.C.A. Laboratories is described as being invested with the human faculties of remembering and forgetting. Using two or three extra electronic tubes, this device may be regarded as the watchdog of television scanning in that it protects the receiver from the electrical counterpart of noise. Thus it earns the assessment of possessing the art of electronic "forgetting"—that is, it throws out bodily sporadic electrical noises. The art of remembering is attributed to its human-like capacity of recalling the well-defined pattern of images emanating from a television station. Goose-like, it keeps step with the perfectly received image on the television receiver.

RECORDING 144 TEMPERATURE POINTS

As ubiquitous as the one-time mosquitoes in the Jersey swamps, an electronic outfit installed on airplanes virtually envelops the craft with temperature recording devices. It has contacts with 144 different points, to record varying temperatures. Meteorological data are recorded in three and one-half minutes—ten times faster than a group of men with pencils and pads.

ELECTRONIC TUBES FOR SERVICEMEN

(Continued from page 336)

economical on voltage control systems than intricate relay set-ups, even if tubes have to be replaced on occasional blowout.

CURRENT REGULATOR TUBE

This is another controller adapted to the purpose of adjusting output when the power source gives fluctuating voltage. The filament of the current regulator tube has a variable resistance which changes in direct proportion to the voltage. That is, as the voltage from the source increases or decreases, the filament responds with decreased or increased resistance, as the case might be. In this way current through the load circuit is always the same. A gaseous atmosphere surrounding the filament safely absorbs the excess heat.

This tube is recommended for the maintenance of constant current in the filaments of radio tubes.

A simple hook-up on A.C. is shown in Fig. 3.

The current regulator tube can also maintain power output at a constant level, re-

HALLICRAFTERS ★ HALLICRAFTERS



COMPLETE STOCKS

I still have large stocks of receivers, 2 1/2 meter equipment, meters, tubes, transformers, resistors, condensers, panels, chassis, and radio parts of all sorts. I sell and rent code teaching equipment. Your orders and inquiries invited.

LET'S ALL PITCH IN!

WE CAN all help win this war by selling our government the communications receivers and equipment they need quickly and in sufficient quantities.

That is the reason I pay *highest cash prices* for used communications equipment.

When this war is over you will be in the market for new equipment and by taking advantage of my offer to purchase your present equipment at highest cash prices you will be in a position to buy new and better equipment than you now own.

Write, telephone or telegraph me description of your used communications receivers, transmitters and parts of standard make; you will be paid cash immediately without bother or red tape. I am particularly interested in *Hallcrafters*.

I also have a store at 2335 Westwood Blvd., West Los Angeles, Calif.

Bob Henry, W9ARA
HENRY RADIO SHOP
BUTLER, MISSOURI

"WORLD'S LARGEST DISTRIBUTOR OF COMMUNICATIONS RECEIVERS"



ardless of variations in potential, when it is placed in series with a power transformer primary as shown in Fig. 4.

THE DEMONSTRATION TRIODE

This triode, introduced by Westinghouse, has its plate coated with willemite, the phosphorescent material. The plate glows spottedly as the electrons impact upon it, according to the action of the control grid. Thus students can actually see electronic action, just as it is seen on the cathode-ray oscilloscope.

THE PHANATRON

Another time-saver is this hot-cathode discharge-tube. It is a rectifier, handling large currents. With vastly increased efficiency, the phanatron can replace the old-type two-tube rectifier combinations.

OTHER ELECTRONIC TUBES

There's a type of phototube that responds only to ultra-violet rays. This tube can be hooked-up in a simple circuit as shown in Fig. 5. It does not have to be shielded from light sources other than the ultra-violet. So far this tube has provided the only efficient means of measuring the intensity of ultra-violet ray equipment.

Then there's the thyatron, which is filled with mercury vapor at a low pressure. The thyatron, highly sensitive and efficient, fills the bill for precision temperature-control; for automatic motor control, and as a time delay switch.

It may be used to control articles passing on a conveyer belt, by placing the grid lead of the tube so as to be sensitive to objects approaching it.

For thermostatic safety control there is the grid-glow tube, a cold-cathode triode in which the grid electrostatically controls the

current flow. This tube may be utilized as an automatic controller for oil-burners with the conductivity of the furnace flame operating it.

This is just a hint of the wide range of jobs, for war and peace, that the electronic tube can master. America's engineers have developed these exceptional instruments.

It's up to America's radiomen to "keep 'em rolling."

SUBMARINE DETECTION

(Continued from page 338)

erated electromagnetically. However a more modern type was developed by Mr. B. S. Smith. The transmitter was provided with an ordinary steel diaphragm with centre boss against which a cylindrical hammer strikes. This hammer is withdrawn against the force of a spiral spring by passing a direct current through the exciting coil. Upon interruption of the current, the spring causes the hammer to strike the diaphragm with a sharp blow.

The chief advantage of this type of transmitter over the bell is that all the operating mechanism is totally enclosed and therefore does not work in water.

The earliest and most simple of all sub-aqueous acoustic receivers as already mentioned was the Broca tube. The Americans have improved this form of tube by replacing the diaphragm by a thick-walled rubber bulb or flat. It is more sensitive than the early Broca type. Another step toward greater ease of binauralling is the development of the magnetophone. Although greatly inferior in sensitiveness to microphones, magnetophones have some advantages for underwater listening, as they are free from

(Continued on following page)

FREE!

with \$1.00 subscription

to

RADIO-CRAFT

**FULL
LIBRARY SIZE
MODERN
WEBSTER
DICTIONARY
416
PAGES**

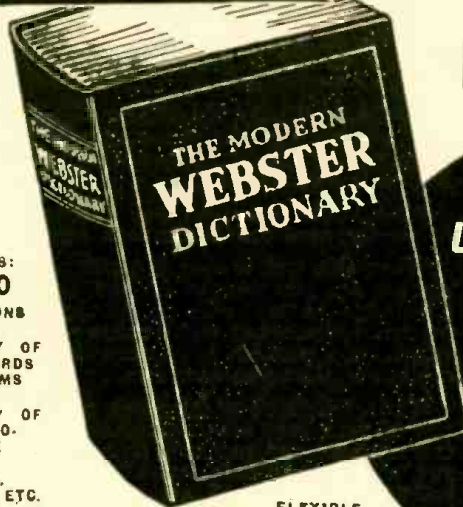

CONTAINS:
22,000
DEFINITIONS
•
DICTIONARY OF
RADIO WORDS
AND TERMS
•
DICTIONARY OF
THE AUTO-
MOBILE
•
TABLES,
TREATISES, ETC.

FLEXIBLE
IMITATION
LEATHERETTE
COVER, SIZE 5 1/4" x 8"

If you will take advantage NOW of our special subscription offer of eight months for \$1.00, we will send you **ABSOLUTELY FREE** and **POST-PAID** this 416 page full library size **MODERN WEBSTER DICTIONARY**—useful and instructive to everyone. This self-pronouncing authoritative dictionary—a new work throughout—contains the most up-to-date words now in common use, 22,000 definitions in all. It also features a Glossary of Radio Words and Terms, Dictionary of the Automobile, Treatises on Practical Syntax, Etymology, Punctuation and Standard English by well known authorities, Metric Tables, Time, State Flowers, National Parks of the U. S., etc.

This is a time limited offer,
so don't delay in returning the Coupon.

RADIO-CRAFT

85 WEST BROADWAY NEW YORK CITY

FILL OUT—MAIL THIS COUPON TODAY!

RADIO-CRAFT, 25 West Broadway, New York, N. Y.
 This is a New Order Extend my present subscription
 Gentlemen: Enclosed you will find One Dollar for which enter my subscription to RADIO-CRAFT Magazine for Seven Months. Send me, **ABSOLUTELY FREE** and **POST PAID**, my copy of the **MODERN WEBSTER DICTIONARY**.
 Name Please print clearly
 Address
 City State
 (Remit by check or money order; register letter if you send cash or unused U.S. Postage Stamps) RC-3-43

SUBMARINE DETECTION

(Continued from previous page)

the vagaries of granular microphones. In order to be able to listen from a ship in motion and to reduce ship and water noises as much as possible, hydrophones, with the rubber block form or of one of the foregoing types, have been enclosed in

fish shaped bodies and towed through the water some distance astern. The modern tendency, however, has been in the direction of inboard listening, by securing efficient acoustic insulation from the hull.
—Purdue Engineer

PROGRESS IN ELECTRONICS AND RADIO

(Continued from page 333)

the mercury arc at the beginning of each cycle by an igniter. Direct-current power transmission is executed in this way, and a large industry has grown up in building enormous rectifier stations for production of aluminum. In these, we use mercury tubes and control the power flow by igniters. As another example of ideas which have been kept in cold storage for many years, we may mention tests made in 1928 with radio echo to measure an airplane's distance from the ground. The idea seemed very promising and tests were made to give the pilot a warning if he was flying into a mountainside. The aviation industry has shown repeated interest, but the finished device, which may be carried by every airplane, is still to be developed. But it is safe to predict that, in the future, airplanes will be piloted by radio echo through mountain ranges, in clouds, and darkness, and come to a safe landing without seeing the ground. The instances of unfinished trends could be multiplied. Frequency modulation has already been well established, but it has still far to go. We can foresee chains of

relay stations on mountain tops, so that the whole country can be connected up in a system of frequency-modulated broadcasting. Such relay chains may be combined with television, which will come into its own when it can acquire a large enough audience. Television in color will then follow, when circumstances permit. The growth of television is likely to have indirect effects in other fields, because it contains so many new ideas which will be useful for other purposes. The relay chains will lead to the utilization of sharp radio beams and still shorter waves. Here is a basis for radio trails which will cross the continent like highways, so that the aviator can fly above the clouds and see his way in three dimensions by radio vision, as unmistakably as if he were looking at rows of street lights on a clear night. Ships will see each other in a fog, and their radio lights will be as indispensable as the red and green lights are now for navigating on a clear night.—From an address delivered on January 26, 1943, during the General Electric SCIENCE FORUM program.

RADIO AND TELEVISION AFTER THE WAR

(Continued from page 337)

technical books dealing with every phase of television broadcasting.) Facsimile broadcasting, now in its infancy, will be a big business, for through it every variety of written matter can be brought by advertisers into the home at negligible cost.

F.M.'S FUTURE

More immediate is the opportunity for new F.M. stations. An ordinary station cannot broadcast Frequency Modulation. Public demand for static-free F.M. reception is enormous and will increase, especially in the cities. The local limitations of television will insure the continuance of regular broadcasting long enough to permit fortunes to be made in the F.M. field. What will happen to our present radios when television and F.M. dominate broadcasting? One possible answer is—they can be sold to a vast European and Asiatic market, particularly short wave sets. A modernized China alone can absorb millions of used American radio sets. Personal two-way radios are on the way for use in private cars, planes and boats, with special sets for campers, hikers, mountain-climbers, fishermen, etc. The manufacture and sale of these low-cost sets, using individual wave lengths (a certain development) will create new fortunes. Soon after the war there will be new portable radios, as small as pocket-size and light in weight, with a new kind of miniature battery rechargeable at home. You may carry a radio as casually as a watch, and it may not be much larger or heavier. There are 100,000,000 potential customers in the U. S. alone.—Forbes Magazine

BRAIN WAVES MADE AUDIBLE?

Dr. R. Fuerth of the University of Edinburgh, in an article in *Nature*, suggests that brain waves, usually recorded on paper ribbons, by a system analogous to radio apparatus, could be converted into sounds, possibly even musical in nature, and thus made audible. An instrument which he is using at the present time, which he calls the "encephalophone" (from the Greek, "recorder of head sounds"), does such, and in a "satisfactory" manner. For example the *alpha* waves associated with epilepsy (which pulsate about 12 per second), and the faster *beta* emanations, (which appear as trills or wavering notes) have been converted into sound waves. Other waves, slower in beat, produce other characteristic tones. If such a device were made commercially it is believed its advantages would lie in its relative inexpensiveness and its compactness.

RADIO AIDS SNOW REMOVAL

During the recent heavy snowfalls in New York City, the gigantic task of removing the snow was aided by the use of radio. Since each foreman has in his coupe a radio tuned to the same wavelength as that in use at the airport, orders could be given which expedited the removal operations with a minimum of lost time. This explains, why, for the first time in years, the snow was removed from New York City's streets, in record time.

R.F. CARRIER COMMUNICATIONS

(Continued from page 346)

derground, using the 300-volt D.C. 1000-ampere power line.

But D.C. application is still a problem. Each case, if taken singly, can be solved, but for universal use the problems still exist.

No doubt careful planning and designing would lead to further advancement.

ON POLYPHASE CIRCUITS

In the use of R.F.C. another important discovery contributed well toward perfection. As perhaps a few know, in the cases of 3 or 4 wire single, double, and polyphase circuits, a bridging circuit had to be provided to establish communications. But in many instances this trick refused to work—chiefly because of mismatched impedances at the transmitter and the receiver.

COUPLING TO CONDUIT

It was the writer's good fortune to accidentally discover another form of coupling for establishing a continuous circuit. This came about in a case where coupling any or all of the A.C. lines did not help. But on completing one side of the transmitter to the metal conduit of the A.C. line through a condenser of definite value, perfect transmission was obtained. This discovery was simultaneous with that of another investigator in this field, whose priority is not to be disputed. The fact is, that this led to additional applications, and ground-circuit transmission was established for R.F.C.

In order to simplify the results, the following explanation is presented: In any given wire or metallic circuit, an impedance is apparent, so that if this impedance can be measured, and the transmitter output matched to this, transmission can be achieved effectively.

Since link output circuits are used and their inherent impedance is very low, they operate on ground circuits of almost any nature. Of course there are limits,—the most obvious of course seem to be those inherent in the material used for transmitting. Cast-iron is poor, but galvanized or cadmium plated steel is good.

TUBE "SHORTS"

(Continued from page 364)

since the maximum voltage applied between grid and filament in most battery types will be under 25 volts.

The next time you are testing battery tubes for short circuits and run into grid-filament shorts and the tubes appear to be otherwise all right, it is suggested that you measure the voltage between filament and grid and if it exceeds 50 volts that you disregard the grid-filament short indication.

Generally a real grid-filament short circuit occurs because the filament has been opened up and the hook tension has been sufficient to pull the loose end of the filament up so that it comes in contact with the grid wires thus causing a short circuit. Whenever this occurs, of course, the filament continuity will be broken and this can readily be determined. Under these conditions, of course, the tube will be inoperative and should be discarded for an open filament rather than a short circuit.

This information is being passed on so that tubes will not be falsely accused of having grid-filament shorts when in reality these short circuits do not exist under service conditions.—Sylvania News



Are you interested in

SOUND MOTION PICTURE PROJECTION?

SUBSCRIBE to INTERNATIONAL PROJECTIONIST, the only magazine published that is devoted exclusively to the mechanical and electrical principles of professional sound motion picture projection. It deals with the arc lamp, film projector, sound track, photoelectric cell, sound amplifier, maintenance and repair of projection equipment, and with every detail of high-calibre, professional motion picture projection. I. P. has the endorsement of leading projection supervisors of the United States and Canada.

INTERNATIONAL PROJECTIONIST
19 West 44th St., N. Y. C.
Enter my subscription for

1 year—12 issues—\$2
2 years—24 issues—\$3
(Foreign—50c per year extra)

Name

Address

SPECIAL

The books listed below have never been sold by us before. The value of each book is 50c. They are exactly the same as RADIO & TELEVISION'S 50c blue books which have been on the market for years.

For a short time only we are selling these at a special reduced price of only 75c for the 3 books. All of the books contain numerous photographic illustrations and diagrams and have stiff flexible cover.

ABC OF TELEVISION
Contains latest material on television developments. It covers theory of scanning; simple television receiver; how the eye sees; the photoelectric cell; neon lamps; need for broad channel width in transmission signals; cathody television signals; cathode ray tube and television receivers; Farnsworth system of television transmission, and other important features.

SHORT WAVE GUIDE
Covers hundreds of short-wave questions and answers; illustrates popular short-wave kinks; gives explicit instructions for building simple short-wave receivers; instruction on the best type of antenna installation; diagram and construction details for building transmitters.

S. W. RADIO QUIZ BOOK
This book covers questions and answers on transmitters, short-wave receivers, ultra short-wave receivers; practical kinks, wrinkles and coil winding data; novel hook-ups for experimenters; how to "hook-up" converters, noise silencers, power supplies, modulators, beat oscillators, antennas, preselectors, 5-meter receivers.

RADIO & TELEVISION
25 W. Broadway,
New York, N. Y.

Gentlemen:
Enclosed you will find remittance for 75c (each, now U. S. stamps or money order accepted) for which please send me at once your 3 books
ABC OF TELEVISION SHORT WAVE GUIDE
SHORT WAVE RADIO QUIZ BOOK
PLEASE PRINT CLEARLY

Name _____
Address _____
City _____ State _____ RC-3-43

PRACTICAL AUDIO THEORY

(Continued from page 354)

PARTS LIST

CONDENSERS

- C1—10-volts, 25 mfd., electrolytic
- C2—.1, 400-volt tubular
- C3—250-volts, 10 mfd., electrolytic
- C4—25-volts, 50 mfd., electrolytic
- C5—180-volts, 10 mfd., electrolytic
- C6—.5, 400-volt, tubular
- C7—50-volts, 100 mfd., electrolytic
- C8, C9, C10, C11—values about .1 mfd., capacity range to suit amplifier system and acoustic conditions

RESISTORS

- R1—1/2 meg., twin pot.
- R2—6,000 ohms, 1-watt
- R3—1/4 meg., 1-watt
- R4—20,000 ohms, 2-watts
- R5—1/2 meg., 1/4 watt
- R6—1070 ohms, 5-watts, wire wound

- R7—11,000 ohms, 5-watts, wire-wound
- R8—85 ohms, 20-watts
- R9—1/4 meg., 1/4-watt
- R10—6,666 ohms, 20-watts

MISCELLANEOUS

- P—Pickup rewired for P.P. output (P.A. or lab. standard)
- CH—250 or 300 henry c.t. audio choke (P.A. or lab standard)
- T—P.A. or lab standard output transformer
- S—Wide-range auditorium type speaker

Notes:

- 1—If low-gain hi-fidelity pickup is used, use higher-mu tubes in place of 6AF5-GTs.
- 2—It may be better to cross the plate leads instead of the grid leads.

Part III of this article will appear in the next issue of Radio-Craft.

RADIO PROPAGANDA

STUDENTS of a new speech course at the University of Michigan are now studying the use of radio propaganda for American and foreign consumption, and also analyzing axis broadcasts, it was recently reported in the Christian Science Monitor.

The purpose of the studies is to show how this psychological weapon, or goodwill builder, as the case may be, depending which way the broadcast goes and to whom, can be handled by those properly trained therein.

The students must listen to and analyze

both British and Axis material, noticing the techniques employed.

Newspapers also are examined to determine what news and what angles should be emphasized in American broadcasts to the foreign countries.

Reference materials for the course comprise data supplied by the Office of War Information, and by the British Intelligence Service.

Practice is given in the preparation of scripts, and a chance to broadcast over the University's station is given the students.

TEST EQUIPMENT MAINTENANCE

By L. W. BURT*

DON'T, MR. SERVICEMAN!

ALL test equipment manufacturers now are working on War products for the Government. Of late, servicemen have sent obsolete test equipment to manufacturers without first finding out whether repair or modernization work could be done or not.

Please read this article carefully so that you will not overtax the present overloaded facilities of both transportation companies and test equipment manufacturers.

ANY article or service for which the demand increases and the supply decreases will become extremely hard to secure, and cause a lot of headaches.

This was never more true than in the case of test equipment and its repair during the present emergency. The small quantity of necessary and critical materials being made available for civilian use coupled with the fact that our armed forces need all the equipment manufacturers are capable of producing has brought about confusion and uncertainty in the minds of many radio servicemen.

It is the sincere desire of all manufacturers that equipment manufactured and sold by them in years previous to this emergency be maintained in good operating condition. They will assist you in every way possible to replace parts or correctly analyze any difficulty you are experiencing without returning your instrument to them for service.

In the past four months the number of instruments which were manufactured from six to ten years ago being sent in to the factory for repair has increased several hundred percent. All manufacturers of test equipment are working at full capacity on high priority production, and it is becoming increasingly difficult to handle repair and recalibration of instruments, especially the old and one time considered obsolete models.

When writing to your service department, it is advisable to give all the information possible in order that the service engineer will be in a position to readily understand the problem and to offer constructive suggestions. The model and serial number of the instrument in question should always be given. As many symptoms of the difficulty as possible should be given, including the type of circuit or tube being tested, the position of all controls, and anything else which you feel will assist the factory in thoroughly understanding your problem.

Radio servicemen could do much for the war effort by following a few simple rules concerning repairs.

*Service Engineer, SUPREME INSTRUMENTS CORPORATION, Greenwood, Miss.

FIRST, contact the service department of the manufacturer to whom you wish to send your instrument, obtain their permission, and follow the instructions given concerning method of return.

SECOND, obtain the necessary priority, as most materials used for repair of instruments are on the Government priority control list and, therefore, not available unless some priority is extended. For servicemen realize that if a priority rating is assigned to a particular order or repair that it does not necessarily guarantee delivery. It only means that an order bearing a rating will be filled if the material is available or as soon as the material becomes available.

THIRD, make all possible repairs yourself. Multimeters, analyzers, and tube testers, as well as signal generators and signal tracers, are not unusual in their circuit design nor do they differ greatly from the same rules, formulas, and laws upon which the receivers and radio equipment being serviced are based. The same Ohm's law, resistors, capacitors, and parts are used, and yet, but a small majority of servicemen obtain circuits of their test equipment and thoroughly study and understand their operation from a mechanical and electrical standpoint.

Multimeter circuits usually look rather complicated; however, if correctly analyzed, they will be found to consist of a large number of very simple elementary circuits. Quite often a small number of resistors or capacitors will be used for many different ranges and functions through the use of switching circuits which unless carefully studied can seem hopelessly complicated. Do not attempt to check the circuit as a whole, but check each individual range or function. Wherever possible replace resistors, capacitors, or other small standard parts yourself from your local parts jobber's stock.

Exact duplicate of parts are advisable wherever possible. However, it is quite satisfactory in many cases to replace such parts as calibrating resistors which were

originally wire-wound, having an accuracy of one per cent, with a high grade metalized resistor of equal or larger wattage rating. Usually if the value of a resistor is above 50 ohms, your local parts jobber will have it in stock, and a 5 or 10 percent resistor will satisfactorily place your instrument in operation and still maintain an accuracy sufficiently high for average service work. Your radio parts jobber is in a better position to know what materials are available and can be used, and it is suggested that you contact them before you send your instrument to the manufacturer for repair.

In most communities some organization has standard voltmeters and ammeters which can be used to check the calibration of your equipment. The standard broadcast radio stations can easily be utilized to check the calibration of your signal generators; and if you have sufficient knowledge of the circuits and operation of your instruments and obtain from the manufacturer recalibration instructions and circuit diagrams, you should be able to handle this work yourself.

Transportation facilities are carrying the greatest loads in the history of this country, and every time you forward an instrument to some distant point for repair you are using space vitally needed for war materials. Because of the tremendous amount of material being transported at the present time, the same careful handling as would have been given your shipment a few years ago is quite impossible. It is, therefore, suggested that if you find it necessary to ship any instrument that you pack it exceptionally well to avoid damage.

Many of the skilled technicians and test men are in the armed service, and upon the shoulders of those remaining with the manufacturer rests the tremendous task of calibrating the thousands of pieces of test equipment being furnished to the Government daily. You can be of great assistance, when your instrument needs service, by cooperating with the manufacturer of your equipment and following his advice.

RECTIFIER SUBSTITUTES

THE acute shortage of radio tubes is causing the serviceman no end of problems in devising ways and means of using types which are available as substitutes for types which cannot be procured. There is perhaps more danger in substituting rectifiers without carefully considering the problems than is the case in substituting most other types of tubes. The best rule which should be followed wherever possible, when rectifier tubes must be changed, is to replace a cathode type tube with a cathode type tube and a filament type tube with a filament type tube. After a substitution has been made it is very important to make certain that the voltage drop in the

tube now being substituted is approximately the same as in the tube type that was replaced, otherwise the voltage supplied to the filter condensers may be so high as to exceed the safe rating of the filter condensers. With electrolytic condensers as difficult to obtain as they are at present, it may become a serious matter if they fail because of excessive voltage.

The substitution of a cathode type rectifier tube for a filament type rectifier tube invariably results in from 30 to 50 volts additional being available across the filter and means that the filter condensers will have to take this extra voltage. If they are already operating close to their maximum

rating, this will probably result in premature filter condenser failure.

The substitution of a filament type tube for a cathode type tube will usually result in less voltage finally being applied across the filter condenser. Another situation, however, will arise in connection with this type of substitution which may be very serious. This comes about because the filament type tube heats up within two seconds, whereas the cathode type rectifier tube requires about nine seconds before the operating temperature reaches a value sufficient to permit normal operation of the tube. Most present-day receivers employ cathode type

(Continued on following page)

RECTIFIER SUBSTITUTES

(Continued from previous page)

output tubes which also require about nine seconds before they are ready to operate. When a combination of cathode type output tubes and cathode type rectifier tubes are employed, voltage is available across the filter when the output tube is ready to draw current so that the voltage across the filter condenser rises slowly. If, however, a fast heating filament type tube is substituted in place of the cathode type rectifier, then the rectifier tube will supply voltage to the filter after two seconds but the drain on the receiver will be practically nothing until nine seconds has elapsed. This means, therefore, that the voltage available across the filter system will be very high due to the fact that low current is being drawn. This voltage in extreme cases may become so high that every by-pass and coupling condenser in the receiver may be blown.

It is important to make certain that the voltage which is delivered to the filter before the output tubes are heated is low enough so that the filter condensers and

other condensers in the equipment will not be destroyed. This has been taken care of in many receiver designs by supplying a self-regulating wet electrolytic condenser at the input to the filter. This type of condenser has a property of having extremely high leakage when the voltage exceeds its rating and this leakage returns to a normal value when this voltage returns to its rated value.

This is a good place to point out also that when the first section of a filter system is replaced, the condenser should be replaced with one of the same type since otherwise the leakage characteristics may result in unexpected surges which may cause permanent damage to condensers in other parts of the circuit.

It is hoped that the points brought out in this article will serve to save the embarrassing situations which might otherwise arise in connection with less careful methods of substitution of rectifier tubes in existing equipment.

BASIC OHM'S LAW

This is the portion of Mr. Shipman's letter (appearing in the Mailbag Section) in this issue, which was mentioned as being deleted. It covers the basic derivation of Ohm's Law, which may appear as "dry" to some, but is the standard derivation as used in most good schools.

SINCE the volt and the ampere are defined separately in both the absolute electromagnetic and electrostatic systems, we must go back to one of these systems to define the practical units.

Ampere showed that the force exerted on a magnet pole in the vicinity of a wire carrying an electric current is proportional to the length of the wire taken perpendicularly to the line joining the element to the pole. Also that it is proportional to the strength of the pole, and the strength of the current. And besides, it is inversely proportional to the square of the distance from the pole to the wire.

Now when $m = 1$ unit pole, $ds = 1$ cm., $r = 1$ cm., and $F = 1$ dyne, we have a unit current flowing in the wire.

Since the absolute ampere is a very large unit, scientists have adopted a smaller unit, 1/10 of this quantity, to represent the practical ampere.

Thus the ampere in daily usage is defined as 1/10th of the current necessary, in a wire bent into the form of an arc of a circle subtended by one radian, to exert a force of one dyne on a unit magnetic pole placed at the center.

The volt is a unit for potential difference and thus is a measure of the work required to move a quantity of electricity from one point to another.

$$\text{Potential Difference} = \frac{\text{Work}}{\text{Quantity}}$$

We can readily see that when $W = 1$ erg, and $Q = 1$ electromagnetic unit of quantity, we have one electromagnetic unit of potential difference. The electromagnetic unit of quantity Q is equal to the product of absolute amperes and time (seconds). And P.D., equals the work in ergs divided by the product of absolute amperes by the time in seconds. Or to put these relationships in formula form: $Q = (Ia) (t)$, and $P.D. = W / (Ia) (t)$.

The electromagnetic unit of potential difference is an exceedingly small quantity, as will be shown.

It has been found experimentally that a current of one ampere (1/10th the absolute ampere) will produce 0.239 calories per second, when completely changed to heat. Joule has shown that one calorie of heat is equivalent to $(4.18) (10^7)$ ergs of energy. Then $P.D. = W/Q = (0.239) (4.18) (10^7)$ divided by 1/10th times one, or equals 10^9 electromagnetic units, of potential.

For this reasonable hypothetical case, the potential difference is 10 to the eighth power electromagnetic volts. This is an unwieldy amount. For practical purposes the volt is defined as 10 to the eighth power electromagnetic units of potential difference.

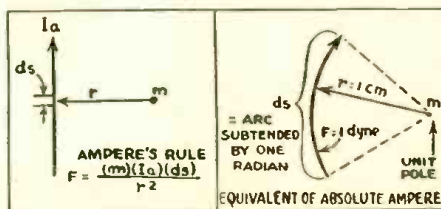

Ohm observed that in a simple circuit (one containing only a source of potential difference and resistance), that a definite relationship existed between voltage, current and a property of the circuit. This property of the circuit is its resistance. This may be expressed as: $I = EK$, where K depends on the circuit.

Now if the unit of resistance is properly chosen the following is true: Amperes equals volts divided by ohms, or as a formula, $I = E/R$.

This is, of course, Ohm's Law, as we are accustomed to seeing it.

Thus, we have defined the ohm in terms of the volt and of the ampere, instead of defining the volt or the ampere in terms of the ohm.

This is the fundamental basis of Ohm's Law, and should be known to all earnest experimenters in radio and electricity.



Good pay, adventure, interesting work! Army, Navy and Commerce need thousands of men who can send and receive Radiotelegraph Code. Learn Code at home or improve your proficiency and rating through the famous Candler System... the same easy, simple system used in training Radiotelegraph Specialists in Signal Corps, Navy, Marines, Coast Guard, Naval Reserve, Airlines and Amateurs. Quality quickly. No long-drawn-out studies. Candler System established over quarter century. Candler has trained world's champions, experts in telegraph communications, can give you fast sending and receiving technique. Tremendous new field for operators both in and out of Armed Services.

Instruction for beginners and operators. You can learn code or increase your w.p.m. speed and improve proficiency. We help you qualify in half the usual time for amateur or commercial license and a good rating.

Write today for FREE Candler Book of Facts. It costs you nothing.

CANDLER SYSTEM CO.

P. O. Box 928 Denver, Colorado, U.S.A. Dept. 3C
Craven House, 121, Kingsway, London, W.C. 2

NEW CATALOG

OF SOUND AMPLIFYING SYSTEMS

AUDIOGRAPH Sound Systems represent the latest in Public Address equipment—a complete line plus pre-tested accessories.

NEW LOWER PRICES

Outstanding quality and performance at prices that help you meet any competition.

WRITE FOR YOUR FREE COPY

AUDIOGRAPH
THE FIRST NAME IN SOUND

John Block Industries—Liberty of Pennsylvania Ave., Plymouth, Ind.

ELECTRONICS IS CATCHING ON!

(Continued from page 335)

at a faster rate,—all these, beyond human hands and eyes, were aided by devices, human in their results, but robot-like in their action, which were operated or controlled by "electronic" tubes.

Of course all tubes are electronic, but somehow it came to be understood that "electronic" tubes were different from the vacuum kind used in home receivers.

These electronic tubes are nothing more than regular tubes filled with a gas or a metallic vapor, instead of being void as vacuum tubes are. However, in the field of power, where large currents are handled, the tubes are no longer glass-enclosed, but made of metal, with water-cooling added to keep them from melting.

The pages of Radio-Craft have been filled with the miracles electronics is performing, and it will continue to relate them, as they become disclosed.

Just as in 1890 it was the birth of the automobile age, in 1920 the birth of radio, and in 1930 the birth of the plane, so in 1943 it seems, we see the birth of the age of Electronics.

• LATEST RADIO APPARATUS •

SELENIUM RECTIFIERS

Emby Products Co., Inc.
Los Angeles, Calif.

THESE instrument and relay rectifiers are the product of years of laboratory research.

The unipolar conductivity of the selenium-to-metal junction is utilized for rectification purposes.

Eight standard types are available, ranging in output from 8 to 120 milliamperes.

The series L Series are supplied in well-insulated metal cases. The S Series come in unbreakable and molded plastic enclosures.

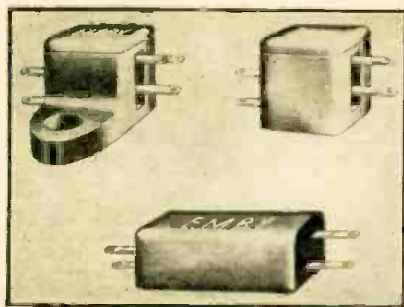

Both types are miniature size, the largest unit weighing less than 1/4 ounce.

Convenient soldering lug lugs are provided eliminating mounting brackets.

These rectifiers do not require any warming-up period, and have been made permanently stable by an exclusive forming process.

Rugged in construction, with high overload capacity they can withstand temperatures up to 158 deg. Fahr.—*Radio-Craft*

STEATITE SOCKETS

E. F. Johnson Company
Waseca, Minnesota

THIS No. 267 steatite socket, featuring low-loss construction, is especially designed to go with the 9000 series and miniature series type radio receiving tubes.

The contacts are of the phosphor-bronze, heavily silver-plated, self-aligning

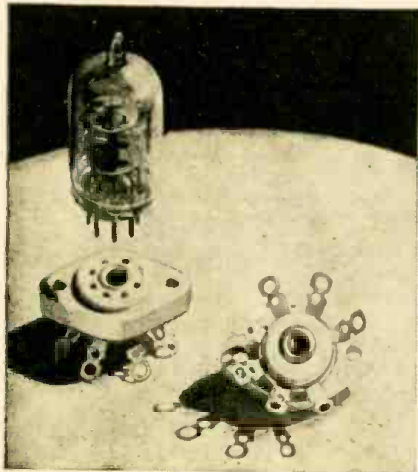

type, so they receive the tiny tube prongs without danger of fracturing the glass base of the tube.

The contacts have been oriented for minimum capacity effect, and a center shield for grounding to chassis is provided.

The steatite insulation is glazed top and sides, with bottom wax-impregnated.

This socket bears Navy Type No. CEJ49401 designation.—*Radio-Craft*

DE LUXE MULTITESTER

Radio City Products Co., Inc.
New York, N. Y.

THE Model 419 multitester combines in one instrument an A.C.-D.C. voltmeter, milliammeter, ohmmeter, inductance and capacity meter, and an ammeter, which makes it suitable for shop, laboratory and field use.

It incorporates in its design the new system of A.C. measurements, which eliminates the copper-oxide rectifier. The A.C. scales are linear, and therefore coincide with the D.C. scales.

Sensitivity of the meter is 2000 ohms per volt, accurate to 2%. The capacity reading is direct, with widespread scales. The ohmmeter portion has its own power supply.

Shorts may be checked through the use of the sensitive low-ohm range.

The meter is fused and the supply double-fused.

Ranges covered are 0 to 5000 volts; 0 to 1000 mils; 0 to 25 amps; 0 to 300 mfd.;



0 to 150,000 ohms; 0 to 15 megohms; and through chart reference, 0.25 to 10,000 henries.

The instrument is available in bench, portable, and laboratory models of cabinets and cases.—*Radio-Craft*

"PLUG-IN" ELECTROLYTICS

Sprague Specialties Co.,
North Adams, Mass.

GONE are the days when time has to be lost in tracing leads, unsoldering leads, mounting the replacement and wiring up. With the new octal-base plug-in type electrolytic condensers, the replacement is affected in a matter of seconds.

Other advantages that accrue at the same time include improvements in the condenser itself. Owing to its "sealed" construction, it can be submerged, exposed to salt-air, reduced atmospheres, high temperatures, reversed voltage, transients, r.f. impedance, or just lay on the shelf for months—none of these things has any effect on its quality or performance.

The case of the condenser is spun aluminum, with connecting seals crimped tight. The values of the various sections are stamped right on the can with the corresponding numbered terminal of the octal base. For example "Term. 3, 10-100 V.", which means at terminal 3 the plus connection to 10-mfd. with a working voltage of 100-volts, is available.

This ingenious arrangement was foreseen by Hugo Gernsback, who, in his editorial in the January 1943 issue, written before he was informed of the production of these items, said: "We will have resistor blocks and condenser blocks to which all connections are made. These blocks will have the individual condensers, or resistors, as the case may be, mechanically fitted in such a way that each one can be pulled out and a new one inserted without any tools, yet the contacts will all be perfect."—*Radio-Craft*

METAL HEATING TRANSFORMER

American Car & Foundry Co.
Berwick, Pa.

THIS heating transformer is designed primarily for heating condenser assemblies involving soldering.

Heating densities are applicable in ten steps, under the control of a foot switching arrangement.

The current is applied through leads to copper blocks mounted on the assembly bench. The work is held in a properly designed jig so that current passes through the easiest way and manual labor is reduced to the minimum.

Soldering is accomplished in 1 1/2 to 2 seconds as compared to the old way where

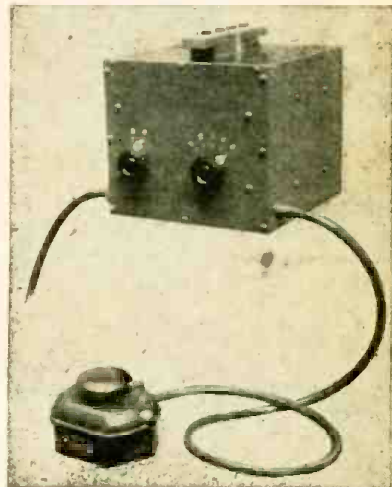

each lead or part had to be soldered separately.

The transformer is a 10-inch cube, and draws 15 to 20 amps. from a 220-volt line.—*Radio-Craft*

VOLTAGE STABILIZER

General Electric Co.,
Schenectady, N. Y.

A NEW voltage stabilizer which provides a constant output of 115 volts from circuits varying between 95 and 130 volts.

This stabilizer is insensitive to load power-factor. It is not affected by variations in load from "no-load" to "full-load," or by changes in power-factor from unity to 0.8 lagging. It is completely self-protecting, and will operate continuously throughout the range from "open" circuit to "short" circuit without damage.

The new stabilizer can be applied wherever close voltage regulation is requisite to good operation—in radio transmitters, electronic-tube apparatus, motion-picture sound-equipment and projectors, telephone apparatus, X-ray machines, photocell equipment; and in the calibration of meters, instruments and relays. Ratings from 50 va to 5000 va are available.—*Radio-Craft*

BOOK REVIEWS

RADIO FROM START TO FINISH by Franklin M. Reck. Published by Thomas Y. Crowell Company. Stiff cloth covers, size 6 x 9 inches, 160 pages. Price \$2.00.

When did Marconi make his trans-Atlantic broadcast? When did modern broadcasting start? What's this FM business and how does it work?

Questions like these, by the hundred, are found answered in this compact little book.

We hear a lot about Maxwell these days, and Armstrong, and DeForest. Their stories are told here, in very interesting style, with plenty of illustrations of persons, events, and apparatus.

What all this amounts to is that here you have a snug little history of radio as regards engineers, entrepreneurs and industries connected with it.

For the young lad (or girl), thinking of a future in radio the author outlines, rather tells, most interestingly, about what goes on in a broadcasting studio, describing the duties and functions of the entire personnel. The book is packed with personal interest items which illustrate how the various steps were taken in radio development. One, of interest to all amateurs, is the story of ham radio. It will be remembered there was a terrific outburst of feeling when they were assigned wave lengths below 200 meters, because in those bands they could not get enough power with spark transmitters. "But with tubes," Dr. Frank Conrad of Westinghouse said, "you don't have that trouble." Thus was the DeForest tube given an impetus that skyrocketed its production to the millions.

I wonder how many of us know that Caruso broadcast in 1910 over a DeForest transmitter? Or that in 1916 David Sarnoff suggested broadcasting entertainment to the masses?

This book is just packed with interesting things like that. It should be in the library of everyone connected with radio.

HENLEY'S TWENTIETH CENTURY BOOK OF FORMULAS, PROCESSES and TRADE SECRETS, by Gardner D. Hiseox, and edited by Prof. T. O'Connor Sloane. Published by Norman W. Henley Publishing Co. Stiff cloth covers, 5½ x 9 inches, 861 pages. Price \$4.00.

Radiomen who experiment with general chemistry, or photography, or the formulation work, will spend countless hours of unrestrained joy in thumbing through this old standby, which covers everything from adhesives to wood-preservation.

All authorities consulted are listed, along with a buyer's guide. Also a list of terms and names which have a commercial and an old-time designation, covering the materials and common chemicals called for in the formulae.

Valuable instructions are given in the use of apparatus and in formulation.

Chapters cover alloys; bronzing; casting molds; cements and ceramics; dyes; electroplating; enamels; etching preparations; jeweler's formulae; lacquers; lubricants; paints; photography (developers, fixers, toners, special treatments, reducers, etc.); rust preventers; solders (all types including aluminum); varnishes; waterproofing; welding powders; wood (stains, preservatives, etc.).

One could not ask for a more complete compendium than this.

ELEMENTS OF RADIO by A. Marcus and Wm. Marcus. Published by Prentice-Hall, Inc. Semi-flexible cloth covers, size 6 x 9 inches, 699 pages. Price \$4.00.

This book is designed to instruct those taking pre-service training in radio, and does it in an unusual way. Instead of giving basic electrical theory first, then radio principles, it presents both at different levels.

In other words a chapter is given on basic electrical and physical laws and this is followed by a chapter on a simple radio receiving set, and a discussion of its components such as the tuner, detector, aerial, etc. In this way the interest of the student is kept up. And also, since theory must have some applications, and some problems to be worked out in order for the theory to be grasped, the group of suggested laboratory demonstrations given in the back of each chapter, and the problems at the end of each chapter, provide this adjunctive material.

The type is very easy to read and the diagrams and pictures illustrating particular phenomena are exceptionally large and clear, and accurately marked, so that comprehension of the idea is attained at first sight.

Schematic symbols used in circuit diagrams are separately given, also the RMA color codes, and hints on soldering.

All in all an excellent text for foundation study, whether in school or learning at home.

A Guide to Cathode Ray Patterns, by Merwyn Bly. Published by John Wiley & Sons, Inc. Flexible paper covers, size 8½ x 11 inches. 40 pages. Price \$1.50.

Now that we have widespread use of the oscilloscope in the factory, in the laboratory, in servicing work, and in schools, where it is used so extensively for adjustments and tests, frequency runs, etc., there is need for a reference which contains all possible usable patterns.

That need, so long unfilled, is now answered by this compact handy booklet. It presents under one cover a summary, in "sketch-and-caption" form, of the patterns encountered in the course of usual laboratory and test bench work.

No space is wasted on hypothetical cases, for those patterns which are shown were obtained with conventional amplifiers and signal generators, which enhances their practical value.

Phase determinations are shown first, followed by frequency determinations.

Modulation patterns, sine-wave and square-wave testing are also covered.

Then follows a discussion of resonance curves and vacuum-tube characteristics.

A brief section takes up miscellaneous patterns.

There is a section devoted to graphic analysis for those with some mathematical background, and a series of perfect half-sine waves suitable for tracing.

No one, working with the oscilloscope, should be without this text.

EXPERIMENTAL ELECTRONICS, by Ralph H. Muller, R. L. Garman, and M. E. Droz. Published by Prentice-Hall, Inc. Stiff cloth covers, size 6 x 9 inches. 330 pages. Price \$4.65.

The object of this book is to present practical information on those types of electron tubes which are not classified as communications devices.

It has the unusual arrangement of preceding each suggested experiment with a discussion of the basic theory involved. And in connection with each discussion all diagrams necessary for a complete understanding of the subject are given. This three-way presentation makes a compact reference, requiring the minimum of searching in outside sources.

Of course a beginner starting from zero or a student who has no access to experimental facilities would find himself progressing slowly. But to one who performs the experiments outlined, the suggested procedures will save considerable time and will inculcate the knowledge with the minimum of effort. For the authors have made, it might be said, all the necessary research in combing current literature and compiling a workable practical instruction tool.

The twelve chapters cover elementary electrical theory; vacuum tubes; photoelectric cells; power supplies; gaseous tubes and their applications; vacuum-tube voltmeters; oscillators; untuned amplifiers; and the cathode-ray tube. There is a diagram or an illustration or a chart, almost on every page, and the type is very easy to read. Such a combination makes it a highly worthwhile text, in our opinion.

BETTER TUBES IN PROSPECT

A recent discovery, that gases can dissolve in certain metals, just as salt dissolves in water, may bring about tubes with much longer life than at present, and which will require much less operating power, was discussed recently by Dr. Harvey C. Rentschler, Westinghouse physicist, before the American Physical Society.

Just how electrons are emitted from

metals has never gotten beyond the hypothesis stage, but Dr. Rentschler's experiments over a period of eight years has led to the conclusion that atoms of hydrogen, nitrogen and even oxygen, go into solution in the filament and cathode metals.

These gas particles then allow the electrons to free themselves from the metal, when it is heated or lighted.

In other words, power from batteries or power supplies, such as is now used, could be reduced in size, since less of it would be required for the same output. Thus savings in material, weight, and size could be effected, which would have revolutionary results.

Undoubtedly commercial use of these principles will be made after the war.

TREASURE LOCATORS

NOW!

You can get the math you need for solving everyday radio and electrical problems



Radiomen and electricians know that the language and the habit of mathematics are essential for real progress in their chosen field. They know mathematics is a tool that they are helpless without.

NOW out of the U.S. Navy Radio Materiel School at the Naval Research Laboratory comes a complete home-study book that is so thorough and so detailed that any reader "who can perform arithmetical computations rapidly and accurately is capable of mastering the principles laid down in this text."

MATHEMATICS for ELECTRICIANS and RADIOMEN
By N. M. COOKE, Chief Radio Electrician U. S. Navy
604 pages, 6 x 9, \$4.00

This book teaches you mathematics from elementary algebra through quadratic equations, logarithms, trigonometry, plane vectors and elementary vector algebra with direct applications to electrical and radio problems. It teaches you how to apply this mathematical knowledge in the solution of radio and circuit problems. In other words, it gives you the grasp of mathematics you need and then shows you how to use your knowledge.

Based on over 8 years' experience teaching mathematics to U.S. Navy electricians and radio operators, the book gives you 600 illustrative problems worked out in detail and over 3000 practice problems with answers so you can check your work.

-----'10 DAYS' FREE EXAMINATION'-----
 McGraw-Hill Book Co., 330 W. 42nd St., New York
 Send me Cooke's Mathematics for Electricians and Radiomen for 10 days' examination on approval. In 10 days I will send you \$4.00 plus few cents postage, or return book postpaid. (We pay postage if remittance accompanies order.)
 Name
 Address
 City and State
 Position
 Company RC-3-43

Complete Plans

For Building Useful and Practical Things at Home. Each issue of Popular Homecraft is crammed with plans for making such beautiful and useful things as: Furniture, Bird Houses, Lamps, Outdoor Garden Furniture, Candle Equipment, etc. Covers little work, tools, wood-working, leathercraft, copper. You'll find "How to make almost everything from the pages of Popular Homecraft. Scores of drawings and photographs make every step simple as A B C. A real "How-To-Do-It" magazine.

Six Months' Trial \$1.00

Send \$1.00 today for trial six months' subscription Money Back If Not Delighted

POPULAR HOMECRAFT

937 Palmolive Building Chicago, Ill.

Trial 6 Months \$1.00



HIGH EFFICIENCY results in Sound National Defense that is why NATIONAL DEFENSE SOUND SYSTEMS are equipped with University Reflex HIGH POWER LOUSPEAKERS UNIVERSITY LABS. 195 CHRISTIE ST. N. Y. C.

SOLDERLESS TERMINALS

ANOTHER study being conducted by the same Branch deals with the use of solderless terminals on Signal Corps equipment. If adopted, these might save considerable time and labor expense in addition to saving solder, which uses a percentage of that precious metal, tin. Other factors affecting the use of such terminals are also being considered.

Standardization is similarly receiving much engineering thought. The Standards Branch at the Signal Corps General Development Laboratory has appointed a member of the Standards Information Section to investigate the various uses of composition resistors, the important characteristics for each use, and the proportion of each use to total requirements. Reasons for this are that binding materials may differ in various resistors, that due to variations in design and construction, resistors of the same nominal rating are not always interchangeable, and so forth.

Mica capacitors, too, came in for their share of attention. The Branch released Standards Sheets on the American Standards Association Wartime Standards on Mica Capacitors. This standardization has been in work for some months, and many believe that it will prove to be the first step toward simplifying the process of design, manufacture, storage and issue of many components of Signal Corps apparatus.

The Automotive and Power Branch of the Signal Corps General Development Laboratory has been running an interesting series of tests on motors to drive power units. According to the latest report, a GMC 2½-ton truck engine was being torn down for examination after having run a 15-kilowatt generator, to which it was directly connected, at 1,200 r.p.m. for 1,516 hours. A Willys ¼-ton Jeep engine, directly connected to a 7½-kilowatt generator, had been running at 1,800 r.p.m. with the equipment under full load for 1,888 hours; it was still running when the report was filed. Among other units tested were a Briggs & Stratton model IL engine in a PE-77-A, a production sample of a PE-77-B, and a model airplane engine which had produced 40 watts from a generator for 494 hours without requiring major repairs.

Index to advertisers

Allied Radio Corp.	324
Audel & Co., Theo.	365
Audiograph	381
Ayers Automatic Code Machines	325
Burk, Henry	369
Candler System Company	381
Cannon Co., C. F.	375
Chartered Institute of America	369
Coyne Electrical School	323
Echophone	355
Embry-Riddle School of Aviation	325
Gold Shield Products	374, 375
Hallicrafters, Inc.	Back Cover
Harrison Radio	375
Henry Radio	377
Hudson Specialties Company	376
International Projectionist	379
Lancaster, Allwine & Rommel	369
McGraw-Hill Book Co.	384
Meissner Manufacturing Co.	359
Midwest Radio Corp.	347
National Radio Institute	321
National Schools	371
National Union Corp.	361
Nelson Company	325
Opportunity Adlets	369
Popular Homecraft	384

RADIO SCHOOL DIRECTORY

American Radio Institute
 Capitol Radio Engineering Inst.
 Commercial Radio Institute
 Electronic Radio-Television Institute
 Lincoln Engineering School
 Mass. Radio School
 Melville Aeronautical Radio School, Inc.
 Metropolitan Technical School
 Nilson Radio School
 N.Y. Y.M.C.A. Schools
 RCA Institutes
 Radio-Television Institute
 Tri-State College

Radcraft Publications, Inc.	372, 378
Radio Publications	373
Radio & Television	374, 379
Sprague Products	326
Sprayberry Academy of Radio	354
Supreme Instruments Corp.	369
Supreme Publications	Inside Front Cover
Technifax	354, 362, 367
Teleplex Co.	325
University Laboratories	384

(While every precaution is taken to insure accuracy, we cannot guarantee against the possibility of an occasional change or omission in the preparation of this index.)

"Treasure"-Finding and "Geo."-Prospecting Articles in RADIO-CRAFT

In view of the many inquiries we have received from some of our readers as to what issues carried articles on treasure-finding, we are reprinting a list which appeared in RADIO-CRAFT some time ago. These articles of treasure locators listed below, with a few adaptations, can be modernized very easily by any ingenious constructor.

"Prospecting by Radio at 1.6 Meters" by Joseph Heller, June 1931.

"How to Build the Radio 'Treasure' Finder" by Clyde J. Fitch, June 1932.*

"How to Build the New 'Treasure' Finder" by E. Franklin Sarver, July 1933.**

"An Improved 'Treasure' Locator" by C. W. Palmer, August 1934.

"Newest in 'Treasure' Locators" by Gerhard R. Fisher, December 1936.

"How to Make a Modern Radio 'Treasure' Locator" by Allan Stuart, September 1939.

"Building a Modern Miniature-Tube Metal-Treasure Locator" by G. M. Bettis, December 1940.***

*Also see "The Radio 'Treasure' Finder," October 1932; and "The Radio 'Treasure' Finder," May 1933 for additional data on this instrument.

**Also see "The New 'Treasure' Finder (corrections)," November 1933; and "Treasure Locator," April 1934 for additional information.

***See letter from Mr. Bettis on page 709 in June 1941 issue.

Radio School Directory

TO OUR READERS

NOW, more than ever before America needs trained radio men. The Army, the Navy and the Air Force are continuously on the lookout for men who have had training in radio. Scores of war industries require radio men in various capacities throughout the country. There now is and there

will be a great shortage of radio men for years to come. **NOW IS THE TIME TO TAKE UP RADIO.**

The leading radio schools listed in these pages are training thousands of men in all branches of radio. We suggest that you read their advertisements carefully.



A CREI COURSE IS THE DIRECT COURSE TO A SECURE FUTURE IN RADIO!

CREI Spare-Time Training Can Prepare You Now for a Responsible, Good-Paying Position That Provides Security and a Future in Radio and Industrial Electronics.

Your opportunity is here today! Your own radio experience backed by CREI modern technical training can equip you with the ability and knowledge to acquire and hold a responsible, radio engineering position. The only difference between an \$1800 "short term" job today and a \$4000 "career" job tomorrow is your technical qualifications as an engineer. Don't waste another day! Make your present job pay for your investment in your future.

WRITE TODAY! If you are a professional or amateur radio-man and want to make more money—let us prove to you we have something you need to qualify for the better job opportunities that can be yours. To help us intelligently answer your inquiry—please state briefly your education, radio experience and present position.



CAPITOL RADIO ENGINEERING INSTITUTE

Dept. RC-3, 3224 16th St., N. W., Wash., D. C.

LEARN RADIO TELEVISION

600 LICENSED graduates placed in past 7 years in shipping, broadcasting, aviation, police, etc.; we also teach radio servicing and repairing; new beginners' class now forming; 60-page catalog free; oldest, largest and best equipped.

MASS. RADIO SCHOOL
18 BOYLSTON ST., BOSTON, MASS., Est. 1899

COMMERCIAL RADIO INSTITUTE

A radio training center for over twenty years. Well equipped. Excellent faculty. Practical resident courses in Defense, Radio Telegraphy, Broadcast, Servicing, Industrial, Television, Aeronautical, Drafting, Mathematics and Studio Technique. Placement bureau. Classes now forming. Catalog upon request.
Dept. D, 38 West Biddle Street, Baltimore, Md.

MASTER COURSE IN RADIO COMMUNICATION

Fits you for a job, advancement or license examination. Course by A. R. Nilson for home study covers same scope as resident school course. Every Nilson graduate to date has commercial license, or a good radio job.

FREE circular 7-C gives full information. Write today.
NILSON RADIO SCHOOL, 51 East 42nd St., New York

Airlines Need

MEN—WOMEN as Communication Experts

TRAIN IN FEW WEEKS

Become part of today's most exciting profession, with a future that's unlimited. Thousands are needed as communications operators by airlines, railroads, private industry. Prepare now for a better job with big pay.

This work is easy to learn, fascinating, and vital to the nation's war effort.

LEARN TO EARN \$30-\$40-\$50 Per Week

At an important communications post you'll be helping America, and getting good pay while doing it. For, if you start your training now, you'll be ready in 10 to 12 weeks to step into this fascinating, big-pay field.

Take advantage of this opportunity now. Write today for full details and low cost tuition. Send a card or letter to . . .

Electronic Radio-Television Institute

Desk 12
2055 Harney St., Omaha, Nebraska

PRE-INDUCTION RADIO COURSES

FOR CIVILIANS AND THOSE ENTERING MILITARY SERVICE

NEW CLASSES NOW STARTING
• RADIO OPERATING • CODE
• RADIO SERVICING

New York Y.M.C.A. Schools
4 W. 64th Street New York City

RADIO TECHNOLOGY



RCA Institute offers an intensive two-year course of high standard embracing all phases of Radio and Television. Practical training with modern equipment. Also shorter specialized courses in Commercial Radio Operating, Radio and Television Servicing, and Aviation Communications. For Free Catalog write Dept. RC-43.

RCA INSTITUTES, Inc.
A Radio Corporation of America Service
75 VARICK STREET NEW YORK



Correspondence Courses in RADIO and ELECTRICAL ENGINEERING

ELECTRICAL ENGINEERING Get good grasp of wide electrical field. Prepare yourself, at Low Cost, for secure future. Modern, simplified, you can understand quickly.
RADIO ENGINEERING Learn fine course in radio, publishing, Radio and Television Servicing, and Aviation Communications. For Free Catalog write Dept. RC-43.
FREE Get copies of school catalogues, student magazines, complete details. SEND NOW!

LINCOLN ENGINEERING SCHOOL, 901 937-C-08, LINCOLN, NEBR.

Pre-Military RADIO

★ Telegraph, Telephone, Teletype, Maintenance ★
★ Melville-trained, licensed ground station and flight technicians are with Major ★
★ AIRLINES, and— ★
★ ARMY—NAVY—MERCHANT MARINE ★
★ Women, too, may qualify ★
★ MELVILLE ★
★ AERONAUTICAL RADIO SCHOOL, Inc. ★
★ 45 West 45th St. New York ★
★ Visit. Open daily 9 a. m. to 10 p. m. ★

Coming! A NEW WORLD of RADIO and TELEVISION

What Part Will You Play In It?

(An Opportunity for Men and Women of All Ages)

• War has accelerated the pace of development in Radio and Television . . . has opened up unheard-of fields of opportunity for men trained for tomorrow's New Radio and Television careers.

• Here, at Radio and Television Institute, far-sighted men are working together to supply the demand for radio television experts who will be needed to occupy key positions in a new world.

• What about you? Will you invest a small portion of your present earnings—a few hours of your time in a sound future . . . train under experts who have kept pace with every modern development in Radio and Television?

Call or write today! Let us prove to you that a career may be yours—with a little effort and expert guidance.

TRAIN AT

RADIO-TELEVISION INSTITUTE

Grand Central Palace Building
48th and Lexington Avenue New York City

★ Licensed by the State of N. Y.

RADIO

PRE-MILITARY TRAINING for MEN of MILITARY AGE

CIVILIAN TRAINING for MEN and WOMEN seeking Careers in Radio
Complete Course up to 8 Months

Write, Phone or Call 9 a.m. - 9:30 p.m.

METROPOLITAN TECHNICAL SCHOOL

RADIO DIVISION DEPT. R
7 CENTRAL PARK WEST, N.Y.
Circle 7-2515 Licensed by State of N.Y.

RADIO COMMUNICATION COURSES

STUDY RADIO BEFORE BEING CALLED TO ACTIVE SERVICE
Our graduates are now actively engaged as radio operators or instructors in
U.S. SIGNAL CORPS • U.S. AIR FORCES
U.S. NAVY • U.S. COAST GUARDS
Instruction by Federally licensed instructors
AMERICAN RADIO INSTITUTE
44 EAST 23d ST. NEW YORK CITY

RADIO ENGINEERING!

RADIO today offers GREAT FUTURE for WOMEN as well as men. Demand for graduates exceeds supply. Courses also in Civil, Electrical, Mechanical, Chemical, Aeronautical Engineering; Business Administration, Accounting, Secretarial Science. Tuition, living costs low. Cosmopolitan student body. Enter June, September, January, March. Catalog.

TRI-STATE COLLEGE 2433 COLLEGE AVE. ANGOLA, INDIANA

A Better FM Receiver!

... better because Hallicrafters are pioneers in FM. Model S-27 (illustrated) was the first general coverage U.H.F. communications receiver to incorporate both AM and FM in one receiver. Hallicrafters, through continuous research, both for our armed forces and civilian use, have become the authoritative source for FM communications receivers.

Hallicrafters Model S-27 FMAM receiver, 15 tubes, 3 bands, cover 27.8 to 46 mc., 45 to 84 mc., 81 to 143 mc. Switch changing from FM to AM reception.

hallicrafters

CHICAGO, U.S.A.



ADV Plans, LLC

Copyright Notice:

The entire contents of this CD/DVD are copyright 2014 by ADV Plans, LLC. All Rights Reserved.

Reproduction or distribution of this disk, either free or for a fee is strictly prohibited. We actively monitor and remove listings on eBay thru Vero.

You are free to copy or use individual images in your own projects, magazines, brochures or other school projects.

Only the sellers listed here are authorized distributors of this collection:
www.theclassicarchives.com/authorizedsuppliers

Please view our other products at
www.theclassicarchives.com,
or our ebay stores:

[TheClassicArchives](#)
[ADVPlans](#)
[SuperShedPlans](#)

